

COMPANION TO  
A Drop of Knowledge:  
The Non-operator's Guide to  
**Drinking Water Systems**

# A Drop of Knowledge

The Non-operator's Guide to  
**Wastewater Systems**



**RCAP**

**RURAL COMMUNITY ASSISTANCE PARTNERSHIP**

an equal opportunity provider and employer

This guide was written by the National Environmental Services Center ([www.nesc.wvu.edu](http://www.nesc.wvu.edu)) at West Virginia University on behalf of Rural Community Assistance Partnership, Inc.

Copyright © 2011

The entire contents of this guide are available on the RCAP website at [www.rcap.org](http://www.rcap.org)

This material is based upon work supported under a grant by the Utilities Programs, United States Department of Agriculture. Any opinions, findings, and conclusions or recommendations expressed in this material are solely the responsibility of the authors and do not necessarily represent the official views of the Utilities Programs.

# A Drop of Knowledge

The Non-operator's Guide to Wastewater Systems



Rural Community Assistance Partnership, Inc.

1701 K St. NW, Suite 700

Washington, DC 20006

202/408-1273

800/321-7227 (toll-free)

info@rcap.org

[www.rcap.org](http://www.rcap.org)

# Table of Contents

ABOUT THIS GUIDE	1
<hr/>	
INTRODUCTION	4
<hr/>	
WHERE DOES HOUSEHOLD WASTEWATER GO? What happens when water leaves the building	10
<hr/>	
HOW IS WASTEWATER TREATED? The steps wastewater goes through at a treatment plant	15
<hr/>	
LAGOONS AND DECENTRALIZED TREATMENT OPTIONS	36
<hr/>	
OTHER IMPORTANT THINGS (including additional information on alternative collection systems)	43
<hr/>	
ADDITIONAL RESOURCES	48
<hr/>	
GLOSSARY	50
<hr/>	



photos.com

# About this guide

Having clean, safe water to drink and use is essential to our everyday lives. We often view our intake as the most important part of our dependence on water. But what occurs after the water is used is equally important to maintaining supplies of sanitary water.

Imagine if you had to drink or cook with the same water that had been used to flush a toilet or fill a bathtub. Without a sophisticated treatment system for wastewater, this could be a reality.



AWWA

Wastewater is created each time you take shower, flush a toilet, run a dishwasher or do laundry. Although you've already used it, that dirty water still has a future.

Flowing from the pipes and drains in your home, wastewater is essentially cleaned and reused. In fact, some of the water flowing from our taps

is someone else's wastewater that has been recycled. But without a thorough treatment of wastewater, we could face severe health consequences.

Drinking water that has been contaminated by feces is one of the most common ways of contracting life-threatening bacteria and viruses. According to UNICEF, one gram of feces can contain 10 million viruses, one million types of bacteria, and 100 parasite eggs. The Global Water Trust estimates 10 million deaths each year are caused by waterborne diseases, including 10,000 child deaths each day. In fact, more than 80 percent of illnesses in the developing world are waterborne.

Many of these diseases and deaths are preventable by ensuring that something as common and simple as water is clean.

Most communities in the United States have the proper equipment and procedures for treating wastewater and creating safe drinking water. But we should all have an appreciation for both parts of the cycle of water—the processes to ensure clean water and the processes to deal with the dirty water. When we recognize that both parts are opposite sides of the same coin, we begin to understand better the importance of proper treatment of our water.

## What this guide is for

Most of us take our wastewater (sewer) systems for granted. We flush the toilet or wash the dishes or our clothes, and, with very few exceptions, the dirty water leaves our home. While most of the time our wastewater is out of sight and out of mind, what goes on behind the scenes to carry out this important function is very complex and requires the input of many parts and people. We all generate gallons of wastewater every day and often don't think about how it is dealt with, yet it often requires so much to provide this service to us—strict health regulations, a knowledge of chemical, biological and technical processes, budgeting to run a business, and miles of infrastructure to make it convenient, to name just a few things.



AWWA

As a leader in your community, making decisions about your community's wastewater system is probably part of your role. And it is an important role. You may be on a board or council that is the highest decision-making body for your community's wastewater system. This means you, along with the other leaders, need to oversee all of the activities that go on in the system—not with an extensive knowledge of each activity, but at least with an awareness of what happens and what is required.



Kentucky RCAP

Whatever your role or capacity is, you are to be congratulated for taking an interest in your community's wastewater treatment processes.

You may want more information about what it takes to provide the vital service of treating wastewater. This guide to the operations of wastewater systems for non-technical audiences is designed to explain a typical small-community water system—from the time wastewater leaves a home, through the collection and treatment system, to the final discharge to a receiving body of water or reuse—in an easy-to-understand manner.

### *Informed leaders make better decisions*

This guide provides an overview of all of the technical aspects of a wastewater system so you can make sound decisions as you manage the system. This guide does not provide all of the detail and expertise to make decisions about operations and processes. You are encouraged to work with your system's certified operator(s) for this purpose and consult with him or her for advanced issues.

Water systems and the agencies and institutions that regulate and provide funding for them at all levels—federal and state—are turning to the concept of sustainability these days. The definitions of sustainability and the characteristics assigned to it have evolved a lot in recent years, but generally the concept includes doing more planning, thinking about the long-term, and finding ways to be more self-reliant. In the coming years, our nation's

water systems will face unprecedented challenges: water shortages, aging infrastructure, an aging workforce, and lack of funding, to name the most obvious issues.

As a local leader, your own actions can set the tone for the rest of the community. Therefore, it is your responsibility to be as informed as possible about the systems and processes that remove wastewater from your community's residences, businesses and institutions and treat it. This guide will supply you with some meaningful information about the state of your community's wastewater treatment. When you have more information, you can make better decisions about current and future operations of your community's system. By reading this guide, you are becoming engaged in the process of learning more about your responsibilities and providing an essential resource in your community.

Remember, clean water is up to you and your community. Be informed. Be engaged. And be a leader.



USDA

**TIP:** As you read this guide, keep a highlighter in hand, or mark pages with sticky bookmarks for parts that are relevant to your system.

# Introduction

## Overview of a community's wastewater and treatment

After clean water is used, it needs to be treated so it can be used again. Used water, or wastewater, is a mixture of liquids and solids carried by water. Within a residence, wastewater is generated by sinks, toilets, showers and bathtubs, dishwashers, and clothes washers. Community wastewater treatment systems may also collect wastewater from commercial establishments, such as restaurants and small businesses; institutions, such as schools, churches, and hospitals; and industrial facilities.

Wastewater is treated for three main reasons:

1. to protect human health
2. to maintain environmental quality
3. for aesthetic reasons

Wastewater can contain pathogenic microorganisms, such as bacteria, viruses and protozoans, which can spread illnesses when people come into contact with them. Untreated wastewater can harm the environment by polluting waterways, making them unfit for aquatic life and human recreation. As the organic material in wastewater decomposes naturally in waterways, oxygen is consumed. If the amount of wastewater overwhelms the capacity of a stream or river to manage the waste, the stream can become depleted of oxygen, resulting in the death of fish and loss of other aquatic life.

Wastewater is also rich in nutrients, such as phosphorus and nitrogen. In excess, these nutrients can cause nuisance conditions in waterways, such as overabundant growth of algae. Under some circumstances, untreated wastewater can produce unpleasant odors and discolor receiving waterways.



*Photos.com*

Residential or domestic wastewater is often categorized as black water or gray water. Black water is generally considered to be generated by the flushing of toilets. Gray water is generated at all other residential fixtures. However, depending on state or local rules, kitchen sink wastewater, because of its generally higher content of organic material and some bacteria, may be considered black water. The entire wastewater stream is a combination of black and gray water.



Generally, there are two ways to think about wastewater treatment: centralized and decentralized. Centralized wastewater treatment involves having wastewater producers, such as homes and businesses, connected to a collection system of sewers that carry the wastewater to a central treatment facility. The wastewater is then treated and discharged to a surface water body, such as a river. Centralized systems are most often found in cities and towns where a higher concentration of residences makes investing in sewers more economically feasible.

In rural areas, it is often too expensive to build sewer systems to serve a dispersed population, and decentralized or onsite wastewater treatment systems are usually used instead. A conventional onsite treatment system uses a septic tank to allow solids to settle out of the wastewater and then discharges the liquid effluent (treated liquid) to an underground drainfield or soil-absorption system typically constructed of perforated plastic pipes. If possible, moving the wastewater from the house to the tank then to the drainfield is done by gravity. The final treatment of the wastewater takes place underground, where the soil and soil microorganisms physically, chemically and biologically break down the wastewater.

In some ways, centralized and decentralized processes have come to be viewed as two separate approaches to wastewater treatment. Centralized treatment systems tend to discharge treated wastewater to surface water and

are ultimately regulated by the federal Clean Water Act, which requires a discharge permit. State environmental agencies typically administer oversight of centralized facilities. Decentralized systems usually serve individual households, with final dispersal of treated wastewater taking place in soil. Because the federal Clean Water Act focuses more on surface discharges than subsurface discharges, regulatory oversight of decentralized systems is usually based on state regulations. State or county health departments are frequently the primary regulators, but this varies from state to state.

Although we still refer to centralized and decentralized wastewater treatment, the distinction between the two is not always clear. For example, some types of decentralized systems have been approved in some states for surface water discharge, and some systems have characteristics of both categories. For example, cluster wastewater systems frequently use septic tanks to separate solids but have sewers that convey liquid wastewater to a community drainfield with subsurface dispersal. This guide focuses primarily on traditional centralized systems—homes and businesses connected by sewers to a common treatment facility. Decentralized wastewater treatment—including cluster systems—are briefly discussed later in the guide.



# How is wastewater treatment regulated?

Prior to the 1970s, wastewater treatment was regulated mainly by states, although some federal regulations were in effect. With the passage of the Federal Water Pollution Control Act (FWPCA) Amendments of 1972, the federal government's role was dramatically strengthened. FWPCA eventually became known as the Clean Water Act (CWA).

The 1972 CWA amendments mandated secondary treatment—additional biological treatment following removal of solids by gravity—which previously had not been required by all states. The amendments also required that any facility discharging wastewater—industrial or municipal—to surface waters must have a permit for all point-source discharges. A point source is a discharge from an easily identifiable location, such as a pipe or a drainage way. The permit program, called the National Pollutant Discharge Elimination System (NPDES), set standards for various wastewater contaminants that dischargers were required to meet. States and tribes were allowed to implement their own permitting programs as long as they met federal requirements. States and tribes that meet federal requirements and administer their own programs are referred to as having “primacy.” The CWA also set water quality standards for concentrations of contaminants in rivers, lakes and streams. These are referred to as ambient water quality standards.

Recent federal regulations affecting community wastewater treatment include the Sewage Sludge Regulations (40 CFR 503), adopted in 1993, which regulate the use and disposal of solids or sludge from wastewater treatment plants. They established limitations for content of heavy

metals and pathogens, set standards for safe handling, and promoted the production of high-quality solids that could be reused.

The Total Maximum Daily Load (TMDL) program, which became effective in 2000, placed additional emphasis on the cumulative effects of all discharges on receiving water bodies. The TMDL program is designed to protect water quality on a watershed basis. The program established maximum amounts of pollutants that a water body can receive and still meet the ambient water quality standard for those pollutants.

A TMDL study takes into account the cumulative amount of the pollutant discharged by both point and non-point sources. Non-point pollution is waste, such as runoff from streets or agricultural operations, that cannot be traced to a specific source. TMDL studies also consider the natural background level of the pollutant. In situations in which an ambient water quality standard is exceeded, permitted dischargers may need to meet stricter NPDES standards. This can result in some wastewater facilities being required to provide advanced treatment.

The net result of the CWA and related federal regulations is that almost all community wastewater treatment plants now provide at least secondary treatment with increasingly more systems providing some form of advanced treatment. More information about secondary and advanced wastewater treatment is in the next section.

# What parts of the wastewater are being treated?

Scientists have developed a number of standardized testing methods to provide treatment plant operators with information on the nature of the wastewater they are treating and the effectiveness of their treatment process. This section covers the major parts of concern in wastewater.

## Solids

Solids are a physical component of wastewater, and separating them from the liquid is one of the main objectives of wastewater treatment. Wastewater solids can be those that float, those that sink, those that are in suspension, and those that are dissolved. Functional definitions of the various forms of solids are based on the tests that have been developed to measure them. For example, dissolved solids are those of roughly molecular size that will pass through a very fine filter and are referred to as total dissolved solids (TDS). Suspended solids are larger particles that stay on the surface of the filter and are referred to as total suspended solids (TSS). Typical residential wastewater usually contains from 150 to 300 milligrams per liter (mg/L) of TSS. After secondary treatment, TSS concentrations are generally below 30 mg/L.

## Biodegradable organic material

The concentration of organic material in wastewater has a large impact on the treatment process. Organic material serves as a food source for bacteria and other microorganisms. In the process of consuming the organic material, the microbes break it down into simpler inorganic compounds, such as water,

carbon dioxide and ammonia. Oxygen is used in this process, and if wastewater was discharged to a stream or river in an untreated state, the dissolved oxygen concentration in the water would drop, potentially resulting in the death of fish or other aquatic life.



*Dr. Patricia Glibert, Univ. of Maryland*

One of the primary functions of wastewater treatment is to allow beneficial bacteria to biodegrade organic material as part of the treatment process. This ensures that by the time the treated water is discharged, there is no significant demand for oxygen resulting from a lack of “food” (in this case, oxygen).

The most commonly used test to determine the organic content of wastewater is the biochemical oxygen demand (BOD) test, which measures the amount of oxygen consumed by a wastewater

sample. The BOD concentration of residential wastewater varies from household to household but is usually within the range of 100 to 300 mg/L. Some commercial facilities, such as restaurants, or institutions, such as hospitals, may generate wastewater with considerably higher BOD concentrations. After secondary treatment, BOD concentrations are typically below 30 mg/L.

## Pathogens

A wide variety of organisms, mostly microscopic, are present in raw wastewater and include some pathogens (i.e., organisms capable of causing disease). Pathogens found in wastewater generally include bacteria, protozoans, viruses, and worms. Bacteria are simple, single-celled organisms. Diseases, including life-threatening ones, can be spread when a person infected with bacterial pathogens passes them on through untreated wastewater to another person, such as when human or animal feces get into water that is then ingested by another person.

Because there are many different types of pathogens potentially present in wastewater, and most are hard to isolate and identify, it is impractical to monitor for all of them. Instead, samples are tested for what are called “indicator” organisms whose presence indicates fecal contamination. Their presence does not necessarily indicate the presence of pathogens, only their *potential* presence. A number of different types of organisms have been used as indicators, but the most commonly used are coliform bacteria.

## Nutrients

Although other chemical compounds are needed to sustain biological growth, nitrogen and phosphorus are usually the two most-critical nutrients. Excessive amounts of these nutrients released to water bodies can cause a condition called eutrophication. Eutrophication is characterized by an overabundant growth of undesirable weeds and algae, leading to low oxygen conditions. Depending on the condition of the receiving stream, a wastewater treatment plant may have to meet effluent limits for nitrogen and/or phosphorus. Total nitrogen (TN) concentrations in residential wastewater range from 20 to 80 mg/L. Total phosphorus (TP) concentrations range from 6 to 15 mg/L. See the table below.

bacteria

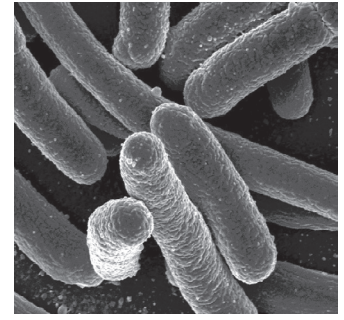

photos.com

salmonella

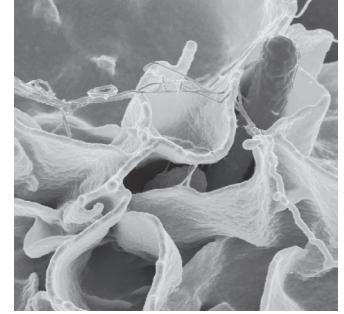

Rocky Mountain Laboratories, NIAID, NIH

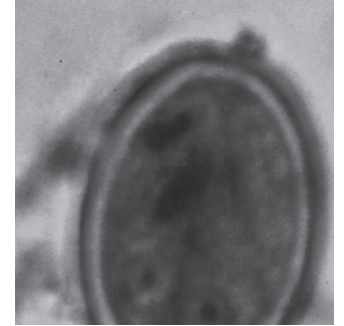
*G. lamblia*

National Environmental Services Center

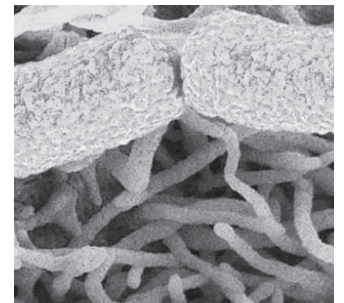
*E. coli* (cryptosporidium)

National Environmental Services Center

Hepatitis (virus)

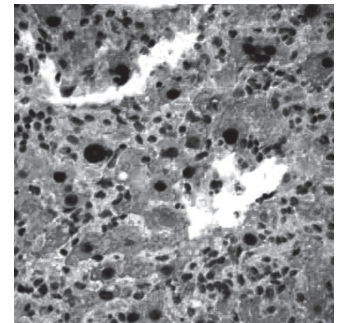

National Environmental Services Center

### Typical concentrations for untreated and treated residential wastewater

WASTEWATER PARAMETER	UNTREATED WASTEWATER*	AFTER SECONDARY TREATMENT	AFTER ADVANCED TREATMENT
Biochemical oxygen demand	100 – 300 mg/L	<30 mg/L	<10 mg/L
Total suspended solids	150 – 300 mg/L	<30 mg/L	<10 mg/L
Total nitrogen	20 – 80 mg/L	10 – 15 mg/L	2 – 8 mg/L
Total phosphorus	6 – 15 mg/L	4 – 9 mg/L	<1 mg/L

\* The ranges presented are for residential wastewater. The characteristics of a wastewater stream may be much different if the system receives significant contributions from industrial, commercial, or institutional sources.

### Other contaminants

Wastewater often includes a number of other substances that can be considered contaminants. Depending on the nature of the collection system, industrial chemicals, such as heavy metals and solvents, and agricultural pesticides can be present in the wastewater. Some synthetic organic chemicals are resistant to being broken down by the biological treatment process. These are referred to as refractory compounds and can include some types of detergents and pesticides.

Other contaminants that are becoming more of a concern include certain types of pharmaceuticals and personal-care products. Although usually present only in minute concentrations, some have been shown to create problems for the human endocrine system (how hormones are secreted). And, although their concentrations are generally reduced as they go through the treatment process, wastewater systems were not designed to treat for these contaminants, and not all are removed.

# Where Does Household Wastewater Go?

Before wastewater can be treated, it has to be transported to the wastewater treatment plant. Most people have some sense that there are sewers that carry wastewater away, but, because they are almost entirely out of sight, few people understand what a wastewater collection system involves.

## Household drainage system

Wastewater's journey from your home to the treatment plant begins in your household drainage system. The drainage system takes used water out of the house. The drainage or removal system is one-half of a house's plumbing system. The other half is the system that brings clean water to the various rooms of your house. The bridges between the two systems are fixtures, such as sinks, toilets, shower stalls and bathtubs, and dishwashers and clothes washers. Clean water comes in and wastewater goes out at these points. In most homes, the drainage system is totally passive and relies on gravity to transport the wastewater.

A house's drainage system is made up of two interrelated parts. One consists of the pipes that carry the wastewater away. The other is the vent system. Each fixture is connected to a main vent, which is the pipe seen protruding from the roof. Larger houses may have multiple main vents. The vent system allows air into the system and serves two important functions. It equalizes pressure in the pipe network so that a vacuum isn't temporarily created when wastewater flows through the pipes. It also allows

sewer gases to vent to the outside of the house through the main vent, keeping sewer odors out of the house.

Each fixture also has a trap, or water seal, that keeps sewer gases from coming up its drain. The trap is the loop in the drain pipe that can be seen underneath a sink. When water flows down a drain, a small amount stays in the trap and acts as a seal to keep sewer gases out of the house. In houses where a fixture is used infrequently, the water in the trap may evaporate, eliminating the seal and allowing sewer gases and associated odors in through the drain.

Wastewater from individual fixtures drains to a central pipe and then exits the house through the building sewer or building-service lateral, which connects to the community sewer network. The building sewer typically has two or more capped clean-out ports to allow access to the pipe if there is a clog—one near or inside the house and one at the property line. The wastewater utility usually has the responsibility for maintenance either at the property line or at the "tap" where the building sewer connects with the community sewer system.

## Conventional gravity-collection systems

The network of underground sewers that carry wastewater to the treatment plant is referred to as the collection system. For the purposes of this guide, we are assuming that the collection system is intended to carry only the community's wastewater. Sewers that carry wastewater that includes human waste are commonly referred to as sanitary sewers. It is important to be aware, however, that some older collection systems were originally designed to accept storm water as well. These combined sewers usually have some outlets where a mixture of storm water and wastewater will overflow to streams during wet weather when the system cannot handle the total volume. And many collection systems that were not designed to accept storm water nevertheless do carry considerable volumes of storm water during wet weather due to deterioration of the pipes. Leakage of storm water and groundwater into the collection system is referred to as infiltration. This can also lead to overflows or situations in which either a portion of the wet weather flow bypasses the treatment process or the mixture is discharged without being adequately treated.

A wastewater collection system is probably the single most underappreciated piece of public infrastructure. Because the system is almost entirely out of sight, few people think about it unless there is a problem.

### COMBINED SEWER OVERFLOWS

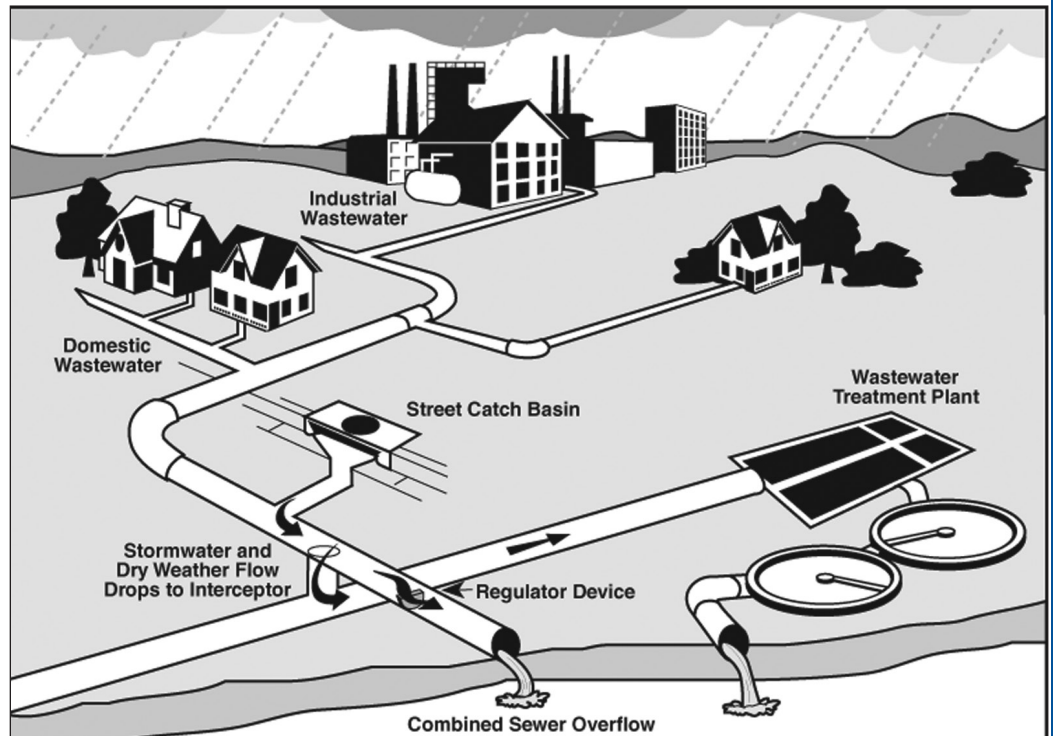

National Environmental Services Center

However, a wastewater collection system represents a huge investment on the part of the community. In fact, the collection system frequently costs more to build than the treatment plant. A community without an adequate collection system may find its opportunities for economic development are limited, regardless of the adequacy of its treatment plant.

A conventional collection system relies on gravity to transport the wastewater, and this requires some careful engineering. The wastewater needs to move fast enough so that solids do not settle out in the sewers, which requires the correct pipe slope or grade. A velocity sufficient to keep solids moving is referred to as the scouring velocity or self-cleaning velocity. At speeds below this velocity, solids begin to accumulate in the pipes.

It is not necessary for the wastewater to constantly move at scouring velocity. However, scouring velocity should be

attained regularly, preferably at times of average daily flow and, at the least, during times of peak daily flow. Flow rates in a collection system vary during the day and mirror water usage. In a community system, the maximum flow rates are usually in the morning when people are getting ready for work and school and again in the evening when people are preparing meals and getting ready for bed.

A diagram of a typical collection system looks like a tree. Buildings connected to the system could be thought of as leaves, with their service laterals (or house sewers) representing small twigs. Different terms are applied to sewer lines, depending on their position in the network. Lateral or branch sewers receive wastewater from groups of buildings and can be thought of as the smaller branches of the tree. Main sewers may collect wastewater from several branch sewers. Trunk sewers collect wastewater from the main sewers. Interceptor sewers collect wastewater from the trunk sewers and deliver it to the treatment plant. As the wastewater moves downstream toward the plant, the average flow increases as branch sewers join to form main sewers and main sewers join to form trunk sewers. The pipe slope can be decreased as the pipe widens while still maintaining a scouring velocity.

Collection systems are more than a network of underground pipes. They also include a number of components, referred to as appurtenances, such as manholes and lift stations. Other common collection

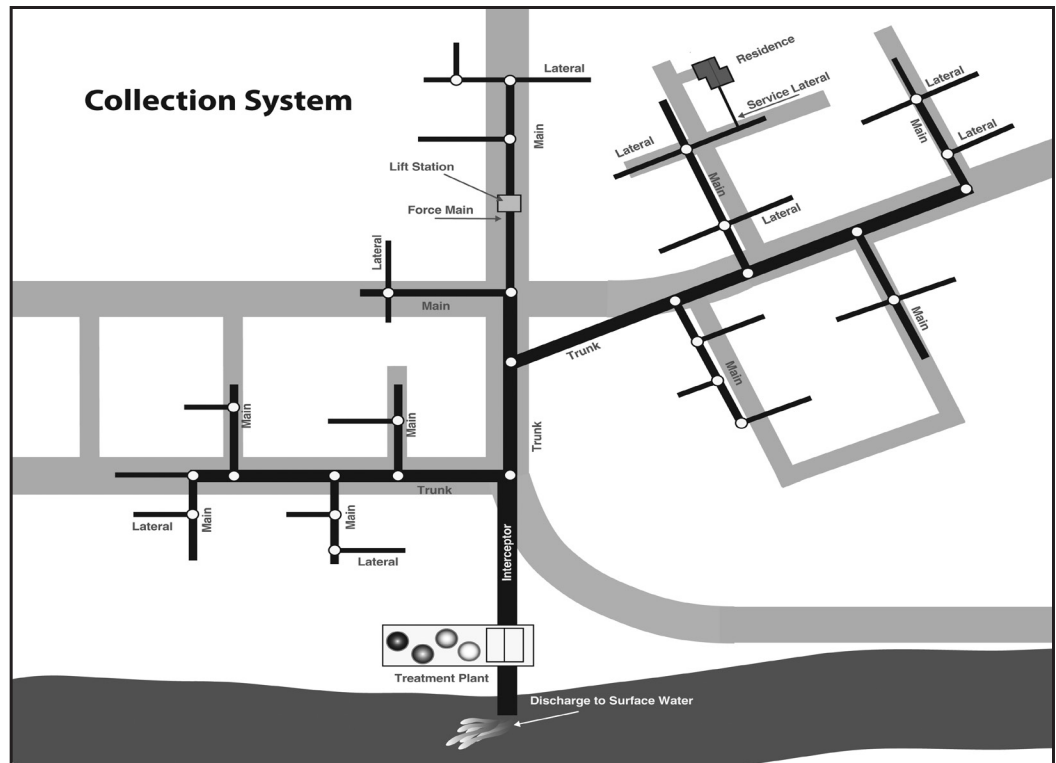

National Environmental Services Center

system appurtenances include backflow preventers, building sewers, lateral branch cleanouts, and flow regulators.

Manholes allow for access to the sewers for the purposes of inspections, cleaning and maintenance. Manholes are installed at crucial points within the system, such as pipe junctions, changes in line direction or slope, and changes in pipe diameter.

Gravity sewers are engineered to take advantage of gravity as much as possible. The treatment plant is usually located at the lowest practical elevation, and the sewers slope downhill toward the plant, mirroring the local topography to some extent. Sometimes, however, the topography



National Environmental Services Center



presents an obstacle to gravity flow. Lift stations are used to move wastewater from a lower elevation to a higher elevation where gravity flow can resume. They are used in instances where maintaining the slope needed for gravity flow would require excavating to depths that would be expensive and impractical.

A lift station includes a wet well where the wastewater is received, the pump or pumps, power supply, a control/alarm system, and ventilation. Some lift stations may also include an odor-control system or a screen or grinder to screen out or handle coarse materials, such as rags. Lift stations are used only when necessary as they can be expensive and require frequent maintenance. Because lift stations run on electricity, a power outage can potentially stop wastewater flow, unless a backup power system is in place.

When the wastewater coming out of the downstream end of a lift station is under pressure, the receiving line is referred to as a force main. The force main needs to be engineered to a higher standard because the wastewater is under pressure and so it can accommodate additional pressure surges, such as when the pump first starts up. The wastewater may also be more corrosive than typical wastewater because its chemical



National Environmental Services Center

nature may change if it sits in the wet well for very long periods between pump cycles. A different type of pipe material may be used to compensate for the pressure and corrosivity.

A wide variety of materials are used for wastewater pipes. They are classified as either flexible pipes (plastic) or rigid pipes.

There are several types of plastic pipe with different properties. Depending on the type of plastic, they may be joined mechanically, glued or heat-fused. Plastic pipe has a number of advantages. The plastic used is inert and is not subject to corrosion or decay from exposure to wastewater. Plastic pipe is also very strong in relation to its weight. It is easy to move and install without heavy equipment. Because plastic is light, it is available in longer lengths than heavier pipe. This reduces the number of joints in the system, which, in turn, reduces the potential for debris snags and root intrusion. Because plastic pipe is non-porous, there is less opportunity both for leakage of groundwater in (infiltration) and leakage of wastewater out (exfiltration). Plastic pipe, however, can tend to float in areas of high groundwater, which can change the pipe slope.

Rigid pipes were used before plastics became available and are still used frequently, especially in applications where flexible pipe would not be appropriate. Rigid pipe materials include vitrified clay pipe (VCP), concrete, asbestos cement (AP), steel, cast iron and ductile iron. Some older intercepting sewers were constructed of layers of brick. Most types of rigid wastewater pipes are lined with plastic or other coatings to protect them from corrosion. Cast iron and ductile iron are often used for force mains. Steel and ductile iron are often used with pipes are exposed or suspended, such as a line crossing above a stream.

## More on sewers

Explanations of pressure sewers, septic tank effluent gravity sewers, and vacuum sewers are in the **Other Important Things** section, starting on page 45.

## Alternative collection systems

Conventional gravity-flow collection systems have been used for many years, and their associated engineering practices are well-established. However, as noted, some of the components of conventional sewers, such as manholes and lift stations, are expensive. In urban areas, where the costs are shared by many people, these types of systems can be affordable. But in less densely populated areas where individual septic systems may not be an option, conventional collection systems can become prohibitively expensive on a per household basis.

A number of alternative sewers have been developed to make collection systems more affordable. They are able to use narrower pipes, which provides a significant cost savings, and clean-out ports replace manholes, providing additional savings. Use of narrower pipe is possible because the wastewater that goes into alternative sewers always receives treatment of some kind (by way of a septic tank or grinder, for example) before entering the pipe. This ensures that any large, solid materials are separated out or ground into smaller pieces.

Because some alternative sewers don't need to rely on gravity to operate, they also don't have to continuously slope downward like conventional sewers. Instead, they can be buried at very shallow depths—just below the frost line—and can follow the natural contours of the land. This saves money on excavation costs and eliminates the need for expensive lift stations.

These features make some alternative sewer designs appropriate for areas with very hilly terrain, extremely flat terrain, shallow bedrock, a high water table, or anywhere the cost and environmental impact of excavating for traditional gravity sewers would be prohibitively high.

When choosing between an alternative and a conventional sewer, the costs of each must be carefully calculated. With alternative sewers, costs can be lowered considerably by using narrower pipes and eliminating some of the more expensive components. However, alternative sewers decentralize some of the wastewater treatment process by transferring it from the plant to the wastewater source in the form of septic tanks or grinder pumps. This means that these dispersed components must be monitored and maintained by someone who must travel from site to site. Whether the savings from the alternative sewer compensates for the additional expense of regular, onsite maintenance depends on the particular circumstances of the community. A technical assistance provider, such as an RCAP staff member, would be able to assist you with this type of determination.

# How is Wastewater Treated?

## Wastewater Treatment Cycle

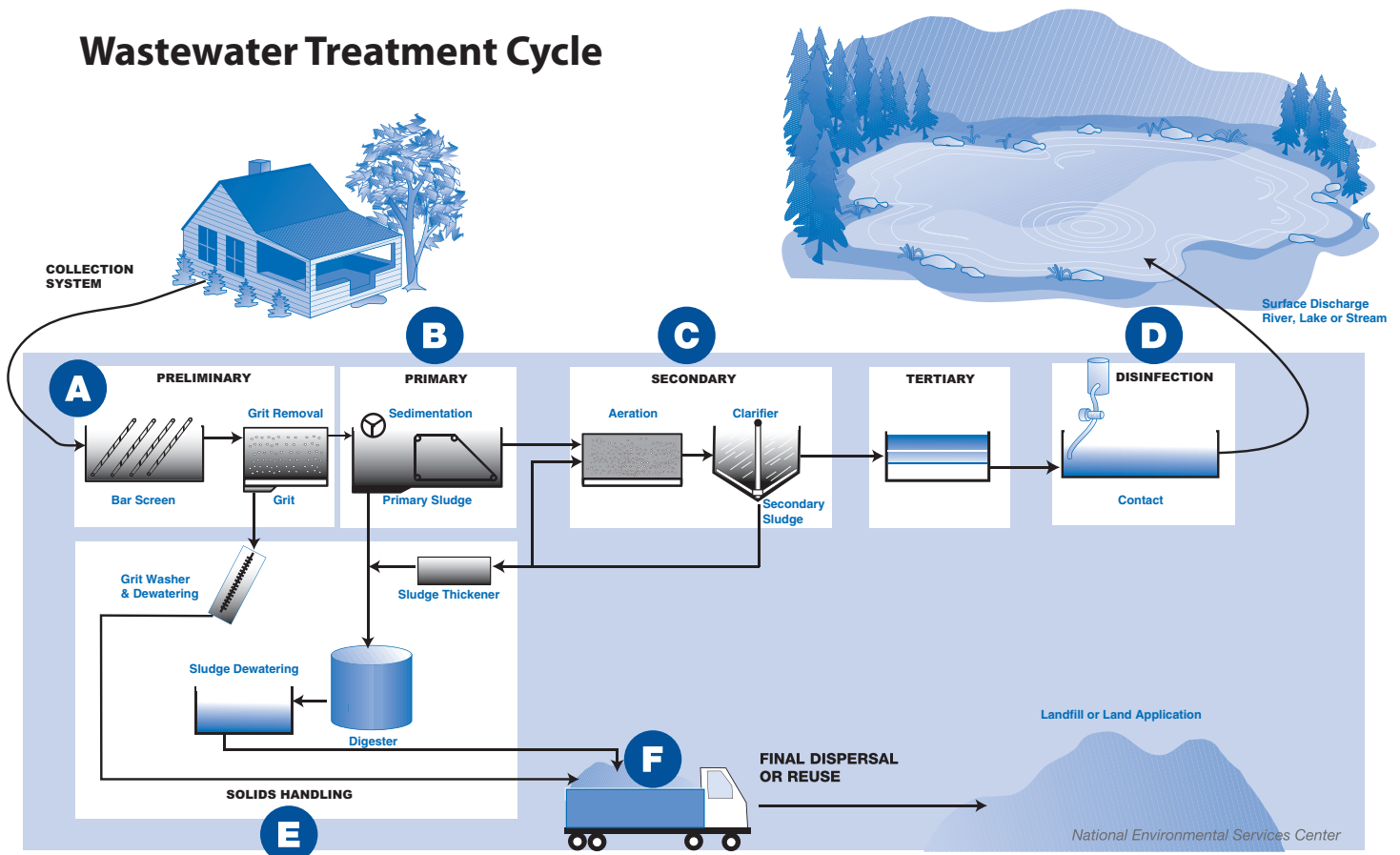

Wastewater treatment is a combination of physical, biological and chemical processes. In most wastewater treatment plants, there are also considerable structural and mechanical components in the form of tanks, pumps, aerators, and monitoring devices that accelerate and assist in these processes.

This section follows the wastewater treatment process through the various stages found in a mechanical plant. Not all communities will have a system that includes all of the processes described in this guide. In fact, some communities rely on relatively non-mechanical wastewater treatment systems such as lagoons or septic systems that

serve individual homes. However, most of the treatment principles described in this section also apply to lagoons and septic systems, which will be discussed later.

The upstream end of a wastewater treatment plant is called the headworks. When the wastewater is brought to the plant's headworks, the process of treatment begins. Wastewater treatment is actually a sequence of processes with some feedback loops. These processes can be grouped into the following broad categories:

- preliminary treatment
- primary treatment
- secondary treatment
- advanced or tertiary treatment
- disinfection
- solids handling
- final dispersal or reuse

# Preliminary treatment

Preliminary treatment, often referred to as pre-treatment, involves removing coarse materials, such as tree branches, rags and plastic bags, by screening, and removing smaller, mostly inorganic (non-decomposable) material, such as gravel, cinders and sand, referred to as grit removal. Some plants grind the material into smaller particles rather than remove it. Preliminary treatment may also involve activities such as flow equalization, septage management, and odor control.

The primary purpose of screening and grit removal is to eliminate materials that could affect downstream processes by damaging equipment, clogging pipes or pumps, or by making treatment processes less effective. Screening and grit removal can also help control odors and protects the health and safety of plant operators.

THE STAGES OF TREATMENT AT A WASTEWATER PLANT	
▶ Preliminary treatment (A)	
Primary treatment (B)	
Secondary treatment (C)	
Disinfection (D)	
Solids handling (E)	
Final dispersal or reuse (F)	
Refer to the diagram showing these steps on page15.	

## Screening

Coarse screening strains larger materials, such as tree limbs, rocks, rags, cans, and wood, from the wastewater by passing it through vertically arranged parallel bars. The wastewater passes through the bars, and the bars hold back the larger pieces.

Screens need to be cleaned frequently because over-accumulation of materials will impede the flow of wastewater into the plant. At smaller plants, screens are sometimes cleaned manually using a hand rake. For systems with combined sanitary and storm sewers, the volume of screened material can

be much higher during heavy rains than for systems that handle only sanitary wastewater. Larger plants typically use some form of mechanical cleaning.

The solids separated from the wastewater are either incinerated or sent to a landfill. The screenings may need to be pressed to remove excess water in order to comply with landfill regulations.

In some plants, coarse racks (the coarsest screens) or screens may be followed by fine screens. Smaller treatment plants occasionally use fine screens in place of primary treatment.

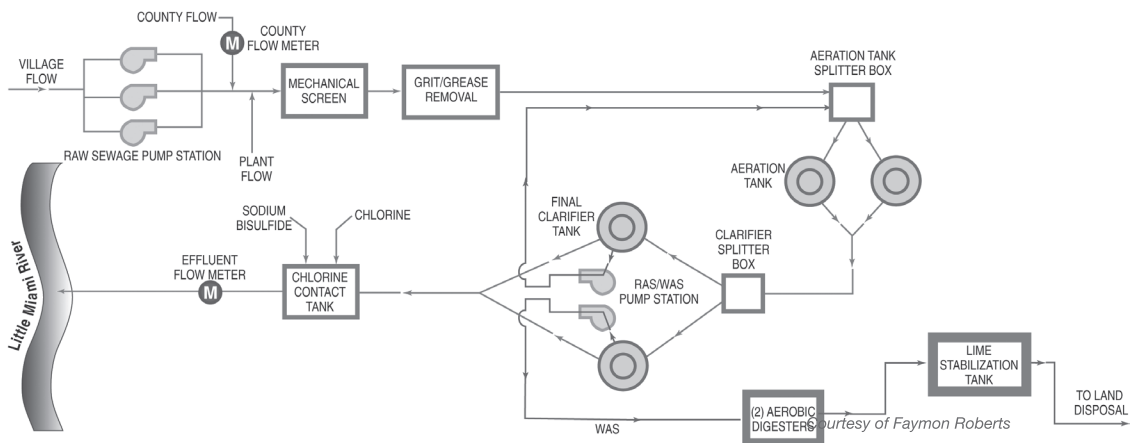



National Environmental Services Center

## Grinding

Instead of screening coarse materials from the wastewater, some systems grind the material into smaller pieces that are then removed by downstream processes. Grinders are referred to as comminutors, macerators, or hammermills, depending on their mode of action. They use blades or teeth to reduce the size of coarse material. When these devices are used in place of racks and screens, they may be preceded by a grit chamber to remove particles, such as gravel and sand, that would cause wear and tear on the grinders. Grinders are also sometimes used in lift stations to protect pumps from coarse materials, especially in areas with cold climates, where screened material could freeze to the rack or screen.

## Grit removal

Grit removal processes usually follow racks or screens. The goal is to remove inorganic particles, such as sand, cinders and gravel. These particles are small enough to pass through the bar screens but can cause problems to downstream processes, such as abrasion of equipment, clogging of pipes, or accumulation in the solids-handling process, which is intended primarily for organic (decomposable) material. Some heavier organic materials, such as corn kernels, coffee grounds, eggs shells, and bone fragments, are also removed as grit.

Grit removal uses gravity, centrifugal force, or a combination of both. In the simplest type of grit chamber, the wastewater flows through a gently sloped chamber in which the velocity is controlled to maintain a speed of about one foot per second. This allows the heavier, mostly inorganic grit to settle out while lighter, organic material remains suspended in the wastewater flow. The deposited grit may be removed mechanically by scrapers or shoveled by hand in smaller plants.

Aerated grit chambers use compressed air to create a spiral flow that assists in the separation of grit. Vortex-type grit chambers use either a turbine or the configuration of the unit to create a cyclonic flow pattern that uses gravity and centrifugal force to separate heavier, inorganic grit.

In some plants, grit is further processed or washed to remove stray organic materials.

## Flow equalization

Flow equalization involves reducing the variations in the volume of incoming wastewater. Flow variations occur on a daily basis. Recall that peak wastewater flow mirrors water usage, with one peak in the morning as people get ready for work and school and another peak in the evening as people prepare meals and get ready for bed. Variations also occur during wet weather. These variations can be huge for systems with a lot of infiltration and for those with combined sanitary and storm sewers.

Flow equalization benefits the system because a larger, costlier facility would be necessary to treat peak flows compared to the average flow. It also benefits the downstream treatment processes as it minimizes the effect of shock loads in which a slug of concentrated wastewater adversely affects the biological processes, and it makes the wastewater quality more uniform.

Flow equalization can be done on an in-line basis, in which the entire wastewater flow passes through an equalization basin. Peak flows are temporarily held in the basin, and a pumping station releases a controlled flow to the downstream treatment processes. Off-line arrangements divert only overflow wastewater into the equalization basin, where it is held for slow release to the plant. Off-line basins are frequently used to capture the initial burst of wastewater during wet weather events in systems with combined sewers or those with considerable infiltration. In combined sewer systems, this “first flush” often has a greater wastewater strength than the remainder of the wet-weather flow due to accumulated materials washed into storm sewers from streets and yards. Depending on their configuration, off-line basins may offer less ability to equalize daily flow variations.

### ***Septage management***

Many treatment plants accept septage, which is the material pumped from the septic tanks of onsite wastewater systems and grease traps. The treatment of septage and grease-trap waste must be carefully controlled as it can have a significantly higher concentration of BOD, suspended solids, fats, oils, and grease compared to typical residential wastewater. Some communities have ordinances that regulate septage, including where in the system it may be added, and requirements for sampling. Preliminary treatment of septage may require aeration if there is a significant volume of it relative to the total flow of the plant.

### ***Odor control***

Odor control is a general plant issue but is especially relevant in the preliminary treatment processes. Odors can be particularly strong in the headworks area. Odors may also be generated from flow-equalization basins, especially if they receive any septage, and from the accumulation of material screened from racks. There are a variety of odor-control practices, including frequent removal of screenings, aeration, chemical oxidation, and the use of special odor-control units.



Ohio RCAP

#### THE STAGES OF TREATMENT AT A WASTEWATER PLANT

Preliminary treatment (A)
▶ Primary treatment (B)
Secondary treatment (C)
Disinfection (D)
Solids handling (E)
Final dispersal or reuse (F)
Refer to the diagram showing these steps on page15.

## Primary treatment

Primary treatment involves letting the wastewater flow slowly through a tank or tanks that allow the settleable solids and floatable materials to separate from the wastewater. The tanks are referred to as primary clarifiers or primary sedimentation tanks. Usually at least two tanks are available for use and are configured so that one tank can be taken out of operation for maintenance.

The tank is designed to allow for the stratification of materials—heavier, settleable solids sink to the bottom, and floatable materials rise to the top. The flow pattern and slower velocity are designed to improve the process. The settled solids are mechanically swept or scraped to a hopper for temporary storage and then pumped to a digester. The removed solids are referred to as primary sludge. The floating layer is removed by mechanical skimmers or sprayed water for further processing.

The amount of solids separated during primary sedimentation varies depending on the holding time in the tank, the tank configuration, and the wastewater quality. Other factors include the freshness of the wastewater, its temperature, the density of the solids particles, and whether there are any industrial contributors to the wastewater. Removal rates of 50 to 70 percent of suspended solids and 20 to 40 percent of BOD can be achieved during primary treatment in plants that are well-designed and -operated. Some plants may add chemicals to enhance the ability of small, suspended solids particles to coagulate into heavier, more settleable masses. In most plants, however, primary treatment relies totally on gravity.

### THE STAGES OF TREATMENT AT A WASTEWATER PLANT

Preliminary treatment (A)

Primary treatment (B)

▶ Secondary treatment (C)

Disinfection (D)

Solids handling (E)

Final dispersal or reuse (F)

Refer to the diagram showing these steps on page 15.

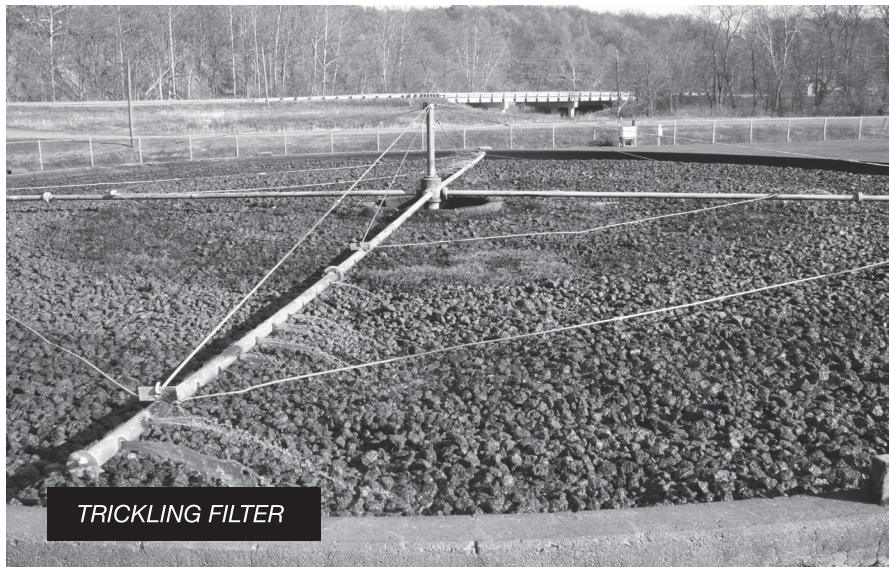

TRICKLING FILTER

Ohio RCAP

## Secondary treatment

Secondary treatment provides further treatment of the wastewater to reduce the amount of remaining organic solids, which are now mainly dissolved and colloidal (tiny particles that will not settle out by gravity), and the BOD associated with the solids. This step also results in the chemical transformation of some wastewater constituents, such as changing ammonia nitrogen to nitrate (nitrification). Secondary treatment needs to produce effluent that has an average BOD content of 30 mg/L, total suspended solids of 30 mg/L, and a pH between 6.0 and 9.0 at all times. Some plants may be required to meet more stringent standards.

Secondary treatment is largely a biological process that relies on microorganisms to decompose the remaining organic matter in the wastewater. The microorganisms are a mixture of bacteria, protozoans, fungi, rotifers, and nematodes, although the bulk of the work is done by bacteria. The wastewater serves as a food source for the microorganisms. Most secondary treatment processes are aerobic, meaning they rely on microorganisms that use oxygen.

Secondary treatment processes are typically divided into two categories: suspended growth and attached growth systems.

In suspended growth systems, the microorganisms providing the treatment are mixed with the wastewater. An activated sludge system is the most common type of suspended growth system. The microorganisms form a suspended, gelatinous floc (clumps of solids) material composed of the microorganisms plus suspended, non-decomposable particles, which are referred to collectively as the activated sludge.

In attached growth, or fixed-film systems, the microorganisms or biomass grow on the surface of a medium. The wastewater is circulated over the biomass surface/medium, and the microorganisms consume and decompose the organic matter. Examples of attached growth systems include trickling filters and rotating biological contactors.

Increasingly, there are more systems that have characteristics of both attached and suspended growth systems. There are also many variations in both suspended and attached growth systems.





Stephen Padre, RCAP

## Suspended growth systems— activated sludge

The activated sludge process uses microorganisms to feed on organic contaminants in wastewater, producing a high-quality effluent. A basic principle behind all activated sludge processes is that as microorganisms grow, they form particles that clump together. These particles (floc) are allowed to settle to the bottom of the tank, leaving a relatively clear liquid that is free of organic material and suspended solids.

Described simply, effluent from the primary treatment process is mixed with microorganisms in an aeration tank, which can be thought of as a biological reaction container. The mixture is referred to as mixed liquor. The mixed liquor is stirred and injected with large quantities of air to provide oxygen and keep solids in suspension. After a period of time, mixed liquor flows to a secondary clarifier, where it is allowed to settle. A portion of the solids is removed as they settle, and the partially cleaned water flows on for further treatment. The resulting settled solids, the activated sludge, are returned to the aeration tank to begin the process again.

Well-operated activated sludge plants are capable of producing a high-quality effluent. They have relatively low construction costs and small land requirements. The activated sludge process is widely used by large cities and communities where large volumes of wastewater must be treated economically. Small activated sludge package plants are used frequently for isolated facilities, such as hospitals or hotels, cluster situations, subdivisions, and small communities.

A basic activated sludge process consists of several interrelated components:

- an aeration tank where the biological reactions occur
- an aeration source that provides oxygen and mixing
- a tank, known as the secondary clarifier, where the solids settle and are separated from treated wastewater
- a means of collecting the solids either to return them to the aeration tank (return activated sludge) or to remove them from the process (waste activated sludge)

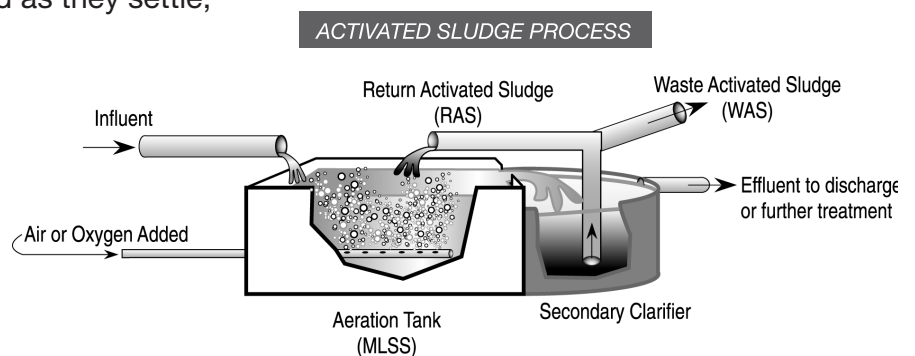

Aerobic bacteria thrive as they travel through the aeration tank. They multiply rapidly with sufficient food and oxygen. By the time the waste reaches the end of the tank (in four to eight hours), the bacteria have consumed most of the organic matter to produce new cells.

The organisms settle to the bottom of the secondary clarifier tank, separating from the clearer water. This sludge is pumped back to the aeration tank, where it is mixed with the incoming wastewater or removed from the system as excess, a process called wasting. The relatively clear liquid above the sludge, called the supernatant, is sent on for further treatment as required.

Because activated sludge treatment is a biological process, monitoring the biological characteristics of the sludge provides important information to the operator on the state of the system. Efficient operation is ensured by keeping accurate, up-to-date records; routinely evaluating operating and laboratory data; and anticipating problems before they become serious. A wide range of laboratory and visual and physical test methods are recommended. Principally, these include floc and settleability performance using a jar test, microscopic identification of the predominant types of bacteria, and analysis of various chemical parameters.

The treatment environment directly affects microorganisms. Changes in food, dissolved oxygen, temperature, pH, total dissolved solids, sludge age, presence of toxins, and other factors create a dynamic environment for the treatment organisms. The operator can change the environment (the process) to encourage or discourage the growth of specific microorganisms.

Chemical testing reveals sludge conditions and can warn of impending process problems. Compliance with the plant's NPDES permit requires specific chemical analyses. Alkalinity, solids (total, suspended and dissolved), biochemical oxygen demand, chemical oxygen demand, nitrogen, and phosphorus are some of the parameters that plant operators must monitor.

## ***Variations of the activated sludge technology***

The activated sludge process can be incorporated into several configurations of a plant's design, including extended aeration, sequencing batch reactors, and oxidation ditches.

### ***Extended aeration***

This process holds wastewater in an aeration tank for 18 hours or more, and the organic wastes are removed under aerobic conditions. Air may be supplied by mechanical or diffused aeration. Mixing is by aeration or mechanical means.

The wastewater is treated to remove large, suspended or floating solids before entering the aeration chamber, where it is mixed and oxygen is added. The solids are allowed to settle out and are returned to the aeration chamber to mix with incoming wastewater. The clarified wastewater flows to a collection channel before being diverted to the disinfection system.

This is the process many manufactured package plants that schools, housing developments, and small communities use. Due to the light food to microorganism loads they handle, extended aeration plants are considered one of the most stable wastewater treatment processes.

The extended aeration process can accept periodic (intermittent) loadings without upsetting the system. Extended aeration does not produce as much waste sludge as other processes. However, wasting is still necessary to maintain proper control of the process.



National Environmental Services Center

## THE STAGES OF TREATMENT AT A WASTEWATER PLANT

- Preliminary treatment (A)
- Primary treatment (B)
- ▶ Secondary treatment (C)
- Disinfection (D)
- Solids handling (E)
- Final dispersal or reuse (F)

Refer to the diagram showing these steps on page 15.

### Sequencing batch reactors

A sequencing batch reactor (SBR) uses one tank for the entire treatment process, unlike a conventional activated sludge system, which uses an aeration tank and a clarifier. SBR systems consist of five common steps carried out in sequence:

1. fill
2. react (aeration)
2. settle (sedimentation/clarification)
4. draw (the effluent is decanted)
5. idle

Sludge wasting usually occurs during the settling phase. The SBR acts as an equalization basin when filling with wastewater, enabling the system to tolerate peak flows or loads.

Effluent enters a partially filled reactor. Once the reactor is full, it performs like a conventional activated sludge system but without a continuous influent or effluent flow. Aeration and mixing are discontinued after the biological reactions are complete, the solids are allowed to settle, and the treated effluent (supernatant) is removed. Excess solids are removed at any time during the cycle.

SBRs are typically used where flow rates are 5 million gallons per day or less. Due to their relatively small footprints, they are useful in areas where available land is limited. In addition, it is easy to modify cycles within the system for removal of nutrients, if necessary. SBRs are cost-effective if treatment beyond biological treatment, such as filtration, is required. SBRs also offer a potential capital cost savings by eliminating the need for clarifiers. SBRs require sophisticated maintenance due to the timing units and controls. Most are now computerized for simpler operation.

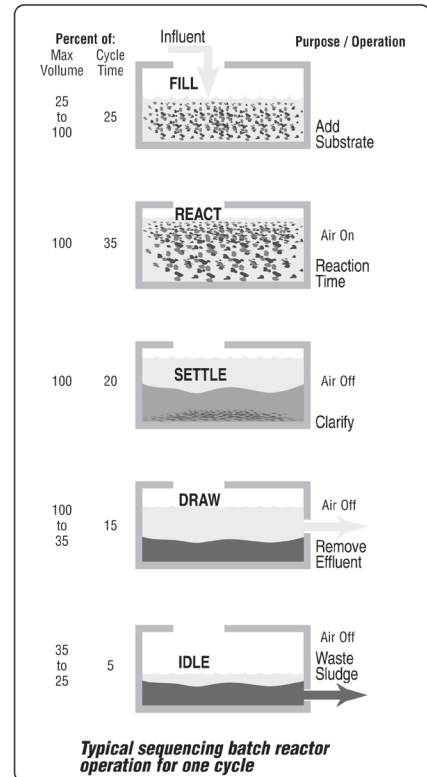

National Environmental Services Center

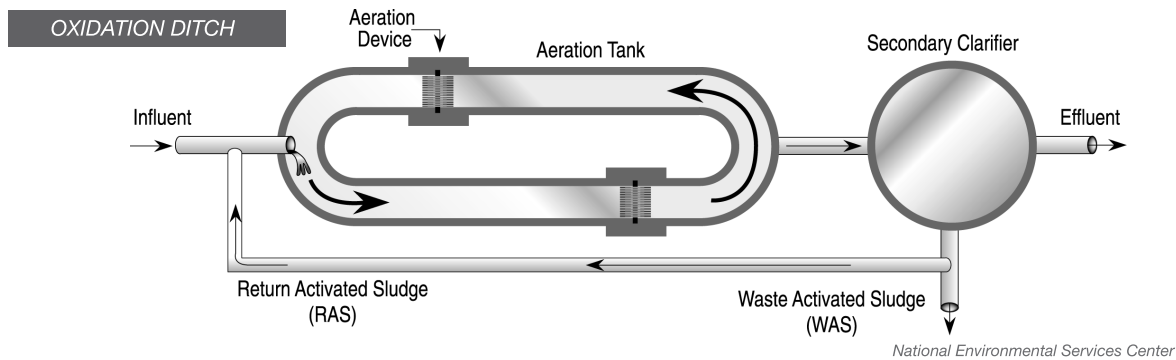

### **Oxidation ditches**

The oxidation ditch is a variation of the activated sludge process. It consists of a ring or oval-shaped channel equipped with mechanical aeration devices, such as brush rotors or disc aerators.

Oxidation ditches typically operate in an extended aeration mode with long solids retention times. Solids are maintained in suspension as the mixed liquor circulates around the channel.

Secondary sedimentation tanks are used for most applications.

Oxidation ditch process plants can be designed to achieve specific objectives, including nitrification and/or removal of biological phosphorus. Due to the constant water level and continuous discharge, oxidation ditch technology does not cause an effluent surge that happens in some other biological processes, such as SBRs.

### **Attached growth systems**

Attached growth or fixed film systems make use of organisms that are attached to a medium or substrate. The principle of treatment is otherwise similar to suspended growth systems: the microorganisms “eat” the remaining organic material in the wastewater while removing most of the remaining BOD. Attached growth systems can also be effective at nitrification (the conversion of ammonia to nitrate).

In all cases, attached growth filters act as secondary treatment devices following primary treatment. Raw wastewater must be treated first to remove the larger solids and floating debris, because these solids can plug the filter.

There are two basic designs of attached growth or fixed film systems: those that hold the media in place, allowing the wastewater to flow over the bed (such as trickling filters) and those where the

medium is in motion relative to the wastewater (e.g., rotating biological disks). In most cases, drains under the media collect the effluent and send it either back through the unit or on to further treatment.

The main advantages of attached growth processes over the activated sludge process are lower energy requirements, simpler operation, less maintenance, and better recovery from shock loads. Attached growth processes in wastewater treatment are very effective for BOD removal and nitrification. Disadvantages are a larger land requirement, poor operation in cold weather, and potential odor problems.

Two types of attached growth systems that are frequently used at wastewater treatment plants are trickling filters and rotating biological contactors.

THE STAGES OF TREATMENT  
AT A WASTEWATER PLANT

Preliminary treatment (A)
Primary treatment (B)
▶ Secondary treatment (C)
Disinfection (D)
Solids handling (E)
Final dispersal or reuse (F)
Refer to the diagram showing these steps on page 15.

**Trickling filters**

Trickling filters are by far the oldest attached growth process. This simple technology has been used for nearly 100 years to provide low-cost, low-maintenance, biological wastewater treatment.

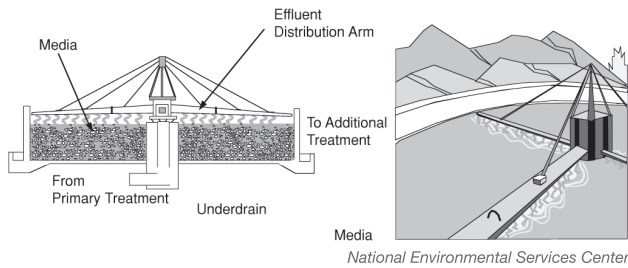

Although they are referred to as filters, they are not designed to provide actual physical filtration. The media are intended to serve only as an attachment site for the biological organisms that provide the treatment.

The most common design is the non-submerged trickling filter. The wastewater is applied to the surface of the filter, such as a bed of rocks, gravel or plastic. The wastewater percolates down through the bed to a drain, where it collects and discharges or is recycled for further treatment. The composition, size, uniformity, and depth of the medium all affect performance.

A jelly-like biological film forms on the gravel or plastic where the growing biomass breaks down the organic matter. The film becomes very thick, and eventually chunks fall off the supporting surface and a new slime layer begins to grow in its place. This dropping off is called *sloughing* (pronounced *sluffing*) and should be a continuous process if the system is managed properly. Without the sloughing action, the medium would clog and develop

anaerobic conditions.

The collected liquid is passed to a secondary sedimentation tank, where the solids are separated from the treated wastewater. The clumps of biomass that drop off must be treated as suspended solids.

Beds of conventional trickling filters are made up of pieces of crushed rock, slag or gravel that are 2 to 3 inches in diameter. The bed is commonly 6 to 10 feet deep, held in place by a reinforced concrete basin. When the medium is made up of plastic tubes, which are very light weight, the height can be much greater. These systems can be as tall as 30 feet. These systems are sometimes called tower trickling filters or biotowers. Most modern trickling filters use plastic packing as the working medium.

Conventional trickling filters are round with rotating arms for distribution of the wastewater. Nozzles on the arms spray the wastewater evenly across the medium. Natural drafts are created by temperature differences between the outside air and air inside the filter. Deep tower filters sometimes require an additional air supply. The temperature of the wastewater is more important to the success of the process than the air temperature.

Trickling filters are highly reliable if operating conditions remain steady and the wastewater temperature does not fall below 55 degrees F for prolonged periods. Sloughing tends to occur during seasonal temperature changes. Because the process is simple to operate, mechanical reliability is high. The trickling filter process is effective for removing suspended materials but is less effective for removing soluble organics.



### **Rotating biological contactors**

Rotating biological contactors (RBCs) consist of a series of closely spaced, circular, plastic disks mounted on a shaft. The disks are partially submerged in wastewater and slowly rotate through it. The surface of the disks provides an attachment site for aerobic bacteria. Oxygen is provided as the disks move in and out of the water. Solids are kept in suspension by the mixing action of the rotating medium. Excess slime on the disks sloughs off from time to time, just as in the trickling filter systems.

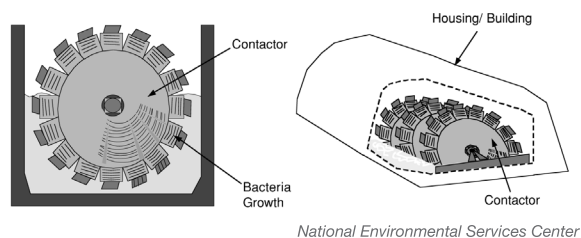

The disks are most commonly made of high-density polyethylene or Styrofoam and are usually ridged, corrugated or lattice-like to increase the available surface area. These systems must be designed carefully to avoid excessive biofilm growth and sloughing problems, which may lead to failure of mechanical parts in the treatment unit. RBCs can be arranged in a variety of ways, depending on specific effluent characteristics and the secondary clarifier design and can be designed specifically for BOD removal or nitrification.

RBCs are often covered with a fiberglass housing to protect the disks from deterioration due to ultraviolet light, to protect the process from low temperatures, and to control the buildup of algae. This type of treatment does not perform well below 55 degrees F.

### **Combined attached growth and suspended growth systems**

Some systems have paired attached growth and suspended growth units within their secondary treatment process. This usually involves a trickling filter followed by an aerated activated sludge basin and a clarifier. There are a number of possible configurations. The combination of the two takes advantage of the strengths of each type of treatment while overcoming some of their weaknesses.

For example, activated sludge systems are considered to be sensitive to shock loads of higher-strength wastewater, while trickling filters are considered shock-resistant. Having a trickling filter precede the activated sludge basin provides a level of protection. Activated sludge systems, however, allow for more operator control over the process than trickling filters.

THE STAGES OF TREATMENT AT A WASTEWATER PLANT
Preliminary treatment (A)
Primary treatment (B)
Secondary treatment (C)
▶ Disinfection (D)
Solids handling (E)
Final dispersal or reuse (F)
Refer to the diagram showing these steps on page15.

## Disinfection

In many systems, after the wastewater has received secondary treatment, it is almost ready for discharge or dispersal. Some systems may first be required to provide advanced (or tertiary) treatment, which will be discussed later. For systems that are not required to provide advanced treatment, the final step before discharge is disinfection. Although as much as 95 to 98 percent of bacteria and other microbes have died off or been removed with the solids by the time secondary treatment is completed, wastewater must still be disinfected before it is discharged into the environment. This is because there are still enough remaining microbes that are potentially pathogenic to create a public health concern. Disinfection is also required by states to prevent the receiving stream from exceeding an established water quality standard for fecal or total coliforms. These standards vary from state to state and sometimes seasonally as well.

Although there are many ways to disinfect wastewater, there are three commonly used options: chlorination, ozonation and ultraviolet light radiation. Disinfection kills or inactivates most of the remaining microbes. Disinfection does not result in the complete death of all microbes, which is termed sterilization.

The effectiveness of these methods depends upon:

- the type of disinfectant
- the concentration or intensity of the disinfectant
- the contact time the disinfectant has with the target organisms
- temperature
- the relative tolerance of the target organisms to the disinfectant
- the characteristics of the wastewater, such as its turbidity, color, and suspended solids content, which can interfere with the disinfectant

## Chlorination

Chlorination is the most commonly used method of wastewater disinfection due to its low cost and its ability to disinfect wastewater at relatively low dosages. Chlorine is available in various forms, including liquefied chlorine gas in pressurized tanks and cylinders; sodium hypochlorite (liquid bleach); calcium hypochlorite, available as a liquid and as solid pellets or powder; and chlorine dioxide, a gas that is generated on-site.



National Environmental Services Center

Chlorine is a strong oxidant and kills microorganisms by damaging proteins, breaking down cell walls and deactivating enzymes. While chlorine in its various forms is an effective and economical disinfectant, it has a number of disadvantages. Chlorine gas is highly toxic, and the risk of accidental release presents a significant health and safety hazard for plant personnel and the general public as liquefied gas tanks are commonly transported by rail and truck. Liquid bleach and calcium hypochlorite,

which are more likely to be used at smaller plants, eliminate some, but not all, of the occupational risks.

#### STACK FEED CHLORINATOR

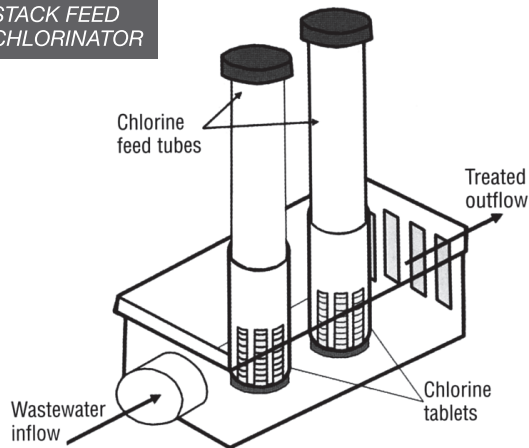

Reprinted with permission of Purdue University Cooperative Extension Service

Increasingly, chlorinated wastewater is required to be de-chlorinated before final discharge to the environment. This is because residual chlorine is toxic to aquatic life and because the chlorine reacts with organic material in the environment to form disinfection byproducts (DBPs) that are also considered to be damaging to aquatic life and carcinogenic to humans.

The most common method for de-chlorinating wastewater is by injecting pressurized sulfur dioxide gas into it. However, because sulfur dioxide is a deadly gas, smaller systems tend to use sodium metabisulfite and sodium bisulfate as safer alternatives. These chemicals can be dissolved in water and dosages given with a liquid chemical feed pump.

## Chlorine safety and handling

Chlorine, whether in gas, solution, or powdered form, is the most dangerous chemical used at most drinking water systems. Proper storage, use, transport, and personal protection can save lives. Exposure to chlorine can lead to:

- skin burns
- lung congestion
- pulmonary edema
- pneumonia
- pleurisy
- bronchitis
- death

Chlorine gas is greenish-yellow in color. It is much heavier than air, which means it will sink to low spots—whether these are near the floor of a building or in a populated valley downhill from the treatment plant. Chlorine gas cylinders must be secured to floors or walls and labeled. Transport vehicles and the building where the chlorine is stored must be identified with signs. Plant staff working with chlorine gas must be equipped with a self-contained breathing apparatus (SCBA) with a mask that has been fitted to the user. Work with chlorine gas cylinders should be conducted only with a trained, SCBA-equipped partner standing by. In the event of a leak in the building where chlorine gas is stored or being worked with, staff in building should keep their heads high and leave the building as soon as possible.

Sodium hypochlorite solution is pale yellow in color and is very corrosive and aggravating to skin and respiratory passages. Calcium hypochlorite powder (called HTH in the water industry) is also extremely reactive. Appropriate personal protective equipment for liquid and powdered forms of chlorine includes:

- safety glasses or full-face shield
- long sleeves
- rubber gloves
- respirator (half or full-face)
- long pants
- steel-toed shoes

Plant managers should notify emergency personnel (police and firefighters) of the type and location of the disinfectant(s) used at the plant.





THE STAGES OF TREATMENT  
AT A WASTEWATER PLANT

Preliminary treatment (A)

Primary treatment (B)

Secondary treatment (C)

► Disinfection (D)

Solids handling (E)

Final dispersal or reuse (F)

Refer to the diagram showing  
these steps on page15.

## Ozonation

Ozone is an unstable oxygen compound (O<sub>3</sub>). Like chlorine, it is a strong oxidant that has been successfully used for years as a disinfectant, although primarily in drinking water treatment plants. It is beginning to be used more in wastewater treatment plants for final disinfection as well as for odor control and advanced treatment. Ozone is generated on-site electrically. It is relatively expensive compared to chlorination, which has limited its use, especially for small systems.

## Ultraviolet radiation

Ultraviolet (UV) light is light of relatively short wave length. UV light has been used for more than 100 years in various germicidal applications. Various types of UV lamps have been developed for use in water and wastewater treatment plants. UV light penetrates and damages the genetic material of bacteria and viruses, making them unable to replicate. Unlike chlorine and ozone, UV light is a physical disinfectant, rather than a chemical disinfectant. It does not create any residual chemicals or result in any disinfection byproducts.

The effectiveness of UV disinfection depends on the intensity of the light and the contact time, which is affected by the flow rate. Because wastewater systems generally have a wide variation in flow rates, a UV system is usually designed for the maximum flow rate.

Historically, the use of UV light disinfection was limited by its relatively high cost. However, due to advances in UV technology and increasing requirements for de-chlorination, UV disinfection is becoming more economically feasible.

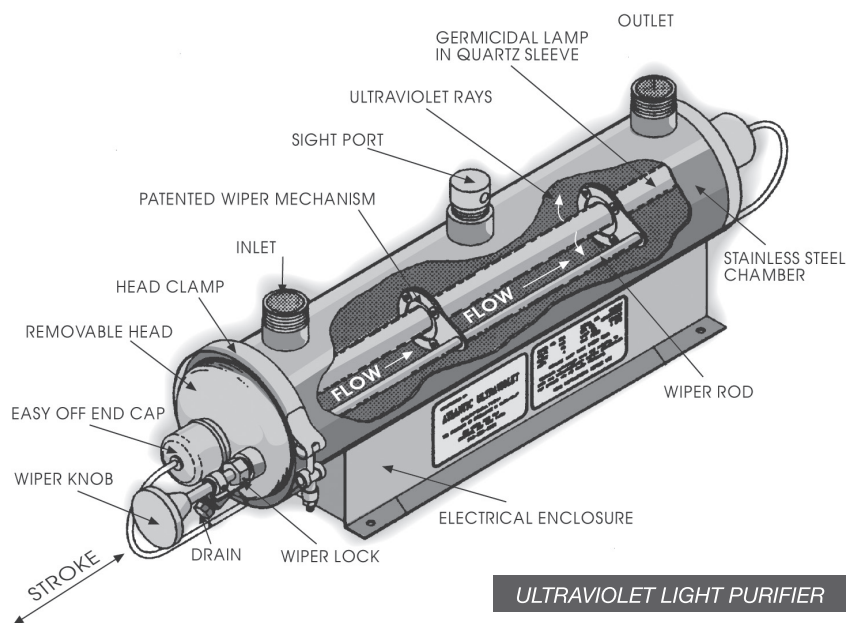

ULTRAVIOLET LIGHT PURIFIER

National Environmental Services Center

## Advanced treatment

Although definitions vary, in this guide, advanced—or tertiary—treatment refers to any type of treatment beyond secondary treatment. Advanced treatment is not universally required, but it is becoming more common, especially for larger systems. Because most small community systems do not use advanced treatment, it is discussed only briefly here. However, as the need to protect drinking water sources and sensitive areas increases and emerging technologies become more affordable, advanced treatment will be more likely to be applied at smaller systems in the future.

There are a number of reasons that advanced treatment might be needed. In some cases, secondary treatment may not be sufficient to protect the quality of surface waters. This is especially true with regard to the nitrogen and phosphorus nutrients. In cases in which water quality standards for surface waters are exceeded, point source facilities may be required by their state to reduce the amount of a contaminant they release. Also, as the population increases and competition for scarce water resources increases, the incentive to recycle and reuse treated wastewater will increase. Advanced treatment may be necessary to meet the criteria for reuse or recycling. Recycled wastewater that is for industrial processes may require advanced treatment to prevent fouling of equipment.

### **Nutrient removal**

Nitrogen and phosphorus can be removed or reduced both biologically and by adding chemicals. The biological processes are variations of the activated sludge process described earlier (page 22). The processes are manipulated to create a biological environment that will result in the microbial conversion of the nutrient.

For example, nitrogen in wastewater is initially in the form of organic nitrogen, which is converted microbially to ammonia. Ammonia is toxic to aquatic life but is readily

converted first to nitrite and then to nitrate in an aerobic environment, a process called nitrification. However, nitrate is a nutrient that can potentially cause the overgrowth of algae and undesirable plant growth in receiving streams. To remove nitrate, it must be converted to nitrogen gas, a process called denitrification, which requires an environment with very little oxygen. By providing both types of environments, either simultaneously or in sequence, nitrogen can be removed.

Both nitrogen and phosphorus can also be removed by a combination of chemical and physical means. Nitrogen is sometimes removed by a process called ammonia stripping. This requires the wastewater pH to be raised to between 10.5 and 11.5 to convert all ammonium ions to ammonia, which is less soluble in water. The wastewater is then passed over a physical structure called a stripping tower, which allows the ammonia to escape as a gas.

Phosphorus can be removed by adding coagulants, such as alum, iron salts, lime, or organic polymers that react with dissolved phosphorus to form a solid substance that will settle out and can be removed in a sedimentation basin. The coagulation process can sometimes be incorporated into the primary or secondary treatment process and does not necessarily need to be separate. Coagulation can also result in the enhanced removal of suspended solids.

Depending on the form of treatment technology used, nutrient removal can result in concentrations of 2 to 8 mg/L of total nitrogen and less than 1 mg/L of total phosphorus. Some states have imposed NPDES limits as low as 3.0 mg/L for total nitrogen and 0.3 mg/L for total phosphorus for treatment plants that discharge to nutrient-impaired waters.

### **Other forms of advanced treatment**

Besides nutrients, wastewater that has received secondary treatment may still contain some suspended solids, such as

dissolved organic matter. This could include some toxic organic compounds that are resistant to biological degradation, trace amounts of pharmaceutical compounds, detergents, and dissolved inorganic matter.

There are a number of different methods that have been developed to provide further removal of these suspended solids. One common method is filtration through a granular medium, such as sand. This process has been used for many years for treatment of drinking water but also applies to advanced wastewater treatment. Membrane filtration processes, such as microfiltration, ultrafiltration, nano-filtration, and reverse osmosis, are also being applied to wastewater treatment. Nano-filtration and reverse osmosis are able to remove particles as small as viruses and hardness ions. However, these processes require pretreatment to prevent fouling of the membranes, and the wastewater created during the membrane filtration process may be too concentrated to recycle back into the plant.

Sand filtration treatment usually results in BOD and TSS concentrations of less than 10 mg/L. Membrane filtration treatment can achieve BOD concentrations of less than 5 mg/L and TSS concentrations less than 1 mg/L.

## Final dispersal

After the wastewater is sufficiently treated, it can be discharged to the environment. There are a number of options for final dispersal, including surface water discharge, effluent reuse, and land application.

### THE STAGES OF TREATMENT AT A WASTEWATER PLANT

Preliminary treatment (A)
Primary treatment (B)
Secondary treatment (C)
Disinfection (D)
Solids handling (E)
▶ Final dispersal or reuse (F)

Refer to the diagram showing these steps on page 15.

## Surface water discharge

Surface discharge is the direct discharge of wastewater effluent to a surface body of water. This is the most common form of effluent disposal. It is a viable option if an appropriate receiving stream is available and if regulatory agencies will permit such a discharge. The required level of effluent treatment varies, but generally the effluent must meet the minimum secondary treatment standards and be disinfected. An NPDES permit or the state equivalent is necessary. Depending on site-specific conditions, more stringent discharge requirements, such as limitations on nutrients, may be applicable.

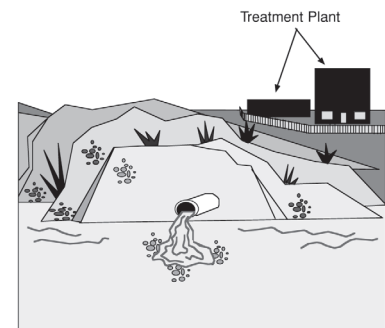

National Environmental Services Center

## Effluent reuse

Effluent-reuse systems use treated wastewater directly or indirectly as an alternative water source. The minimum required treatment for reuse consists of primary and secondary treatment. Advanced treatment is required when high-quality reclaimed water is needed for sensitive areas, such as agricultural crops for human consumption. The factors that affect the feasibility of effluent reuse include: treatment and transportation costs; availability and cost of potable water; reclamation potential of the wastewater; and water quality standards.

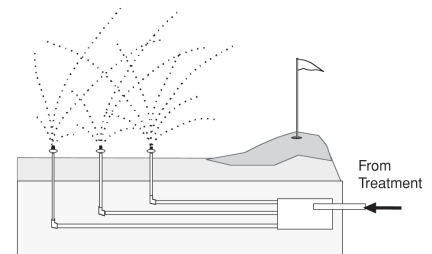

National Environmental Services Center

## Land application

Small systems may be permitted to apply wastewater effluent to land surfaces. Methods of surface disposal include overland flow, rapid infiltration and spray irrigation. These methods combine additional treatment with final dispersal.

In overland flow dispersal, wastewater effluent is applied at the upper end of a treatment area, and it flows in a thin film over the site before it reaches a runoff collection ditch. The ditch may then transport the remaining effluent to a reuse option or surface water discharge point. With this method, plants on the land may absorb the effluent and remove the nutrients, or the wastewater may evaporate. Although best suited to sites with impermeable soils, overland flow has been used successfully on moderately permeable soils.

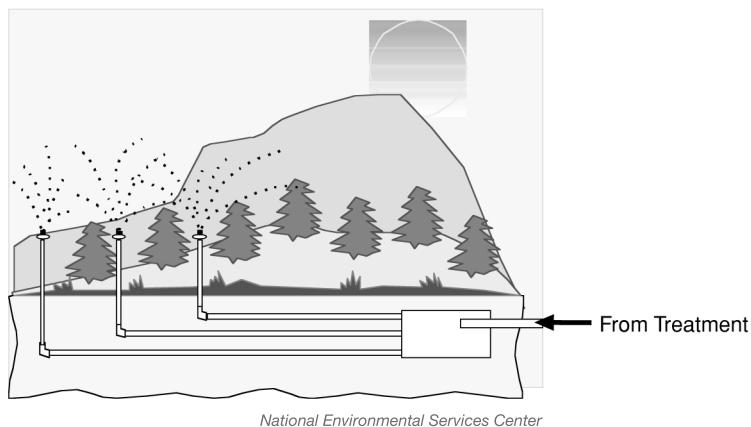

Rapid infiltration systems apply wastewater effluent to highly permeable soils, such as sand and loamy soils, by spreading it in basins or by sprinkling it on ground surfaces. As the effluent moves through the soil, it undergoes additional treatment. A portion of the treated effluent may eventually reach the groundwater. Vegetation is optional, although a grass cover helps remove suspended organic and inorganic solids and nitrogen.

Spray irrigation systems apply treated effluent above ground to reclaim and disperse wastewater. The area to be irrigated must be vegetated and landscaped to minimize runoff and erosion. The wastewater must be treated to a level high enough to protect public health and reduce odors. For this reason, the wastewater must be disinfected. After treatment and disinfection, a pump equipped with timers sends the wastewater under pressure through the mains and lines of the spray distribution system at preset times and rates.

## What happens to the solids?

We have examined how wastewater is treated from the time it enters the plant to the time the treated liquid is discharged. However, at almost every step in the process, semi-solid residues are produced. Collecting, treating and disposing of them is equally challenging, if not more so, than treating the liquid component of the wastewater. For example, as much as one-third of the BOD load of the initial wastewater stream ends up in the primary sludge, the solids produced during primary treatment. Without proper management, these solids can create a major odor problem as the organic component decomposes.

Although we refer to these residues as solids, they are often more liquid or semi-liquid than solid. Because of their high water content, these solids have a high volume. This makes them difficult to handle, store and transport.

Formerly, this residual material was referred to as sludge. The term *sludge* now generally refers only to solids that are still part of the treatment process at the plant, such as secondary sludge collected from the secondary treatment process. Once solids have been processed and have met the criteria for beneficial reuse, they are referred to as biosolids.

The nature of the solids is highly variable from system to system and even within the same system. Primary sludge has different characteristics than secondary sludge. The solids produced from

an activated sludge plant are different from the solids produced by a trickling filter. Some treatment processes work better for some types of solids than others.

Some of the different treatment processes for solids include thickening, dewatering, conditioning, stabilization and drying. Thickening and dewatering reduce the volume of the solids. Conditioning helps make the dewatering process more effective. Stabilization and drying produce end products that are free of pathogens and will not further decay or produce foul odors.

### Thickening

Thickening decreases the volume of the solids by removing some of the liquid. This can be achieved by gravity or by mechanical means. Methods using gravity involve allowing the sludge to settle and compact in a tank similar to a primary clarifier. The compacted sludge is removed from the conical bottom of the tank. Thickening can also be achieved by extending the holding time in a primary clarifier to allow for more compaction, but this can sometimes interfere with the primary treatment process.

Mechanical means of thickening include the use of centrifuges, gravity-belt thickeners, and rotary drums. Gravity-belt thickening involves feeding solids on to a porous moving belt that allows water to drain from the sludge. The process requires the sludge to be chemically conditioned to be effective. Rotary-drum thickening involves passing the sludge, which has been conditioned with polymers, through a series of rotating, perforated, cylindrical screens, which separate the water from the thickened sludge.

Although the volume of the sludge is greatly reduced, the thickened sludge is still semi-liquid and would need to be transported in a tank truck if it were to be moved to another facility for additional treatment.

#### THE STAGES OF TREATMENT AT A WASTEWATER PLANT

Preliminary treatment (A)

Primary treatment (B)

Secondary treatment (C)

Disinfection (D)

▶ Solids handling (E)

▶ Final dispersal or reuse (F)

Refer to the diagram showing these steps on page 15.

### Dewatering

Like thickening, dewatering reduces the liquid content of sludge. However, compared to material that has been thickened, which is still relatively slurry-like, dewatered sludge is more solid and can be shoveled, moved by belt conveyors, and transported in dump trucks rather than tank trucks. Although dewatered sludge may require conditioning, ease of handling often makes the extra processing worthwhile. Dewatering is usually necessary if the final solids are to be landfilled, composted or incinerated. Common dewatering methods

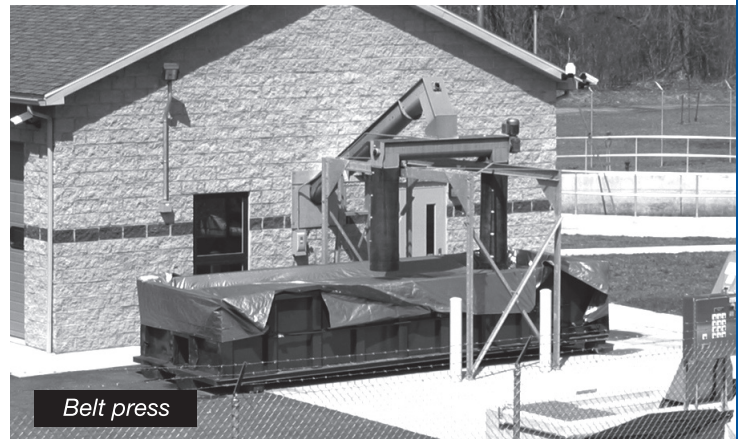

National Environmental Services Center

use various types of centrifuges, filter presses, drying beds and drying lagoons.

Belt-filter presses involve feeding conditioned sludge on to porous belt conveyers, where water is removed first by gravity and then by pressure. Belt-filter presses have lower capital and operating costs than other mechanical dewatering devices and are easier to maintain.



SLUDGE-DRYING BEDS

National Environmental Services Center

The most widely used dewatering method, especially for small and rural communities, is sludge drying beds. Sand drying beds involve spreading the sludge over a bed of sand that is 8 to 12 inches deep. Moisture is removed by drainage through the sand and by evaporation. An underdrain is necessary for removal of the separated water. Paved drying beds have been used as alternatives to sand drying beds. These also require an underdrain.

The advantages of drying beds are that they have very low capital costs, low energy consumption, require little or no chemical conditioning, and require little in terms of operator skill and attention. However, they take up a lot of space and can be affected by climatic conditions. They can be covered in areas where rain and snow are common. Drying lagoons have sometimes been used for dewatering digested sludges. They are used mostly in areas with high rates of evaporation.

### Conditioning

Conditioning usually refers to the addition of chemicals to the sludge to assist with the dewatering process. Conditioning chemicals include synthetic organic polymers and inorganic chemicals, such as ferric chloride, alum and lime. The chemicals do not directly remove water from the sludge but rather alter the characteristics of the sludge so that dewatering processes that follow are more effective. The chemicals are usually applied in a liquid form rather than added dry. Because of the amount added, the inorganic chemicals can increase the final volume of the solids significantly.

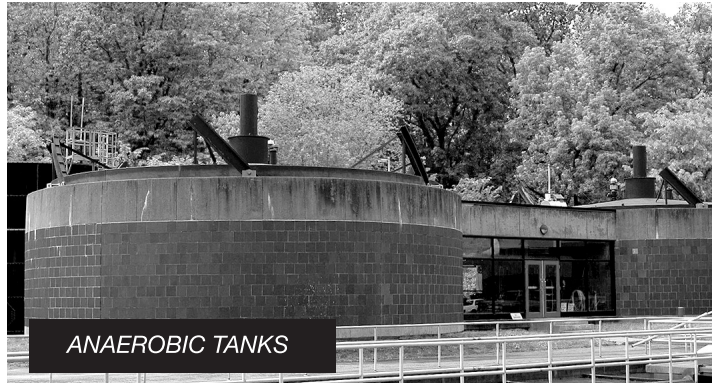

ANAEROBIC TANKS

National Environmental Services Center

### Stabilization

Stabilization refers to processes used to produce a final product that has little or no potential to further decompose and create undesirable odors and that is free of pathogens. Some commonly used stabilization methods are alkaline stabilization, anaerobic digestion, aerobic digestion, and composting. Each of these methods has a number of variations.

Alkaline stabilization involves adding alkaline or basic material to the sludge, which raises the pH to a level that will eliminate microorganisms. Typically, either hydrated lime or quicklime is used, although fly ash and cement kiln dust are sometimes used. Alkaline stabilization can be conducted either before or after dewatering. Because some alkaline stabilization processes are exothermic (heat-releasing), they have the benefit of deactivating worm eggs in the sludge.

Anaerobic digestion involves the controlled decomposition of organic (and some inorganic) matter in the sludge in a closed, heated vessel with no oxygen. This fermentation process has been used for some time, resulting in continual improvements. The process produces significant amounts of methane gas along with carbon dioxide and small amounts of other gases. The amount of methane generated can be enough to make its collection worthwhile even in smaller plants. With the development of microturbines, some smaller wastewater treatment facilities have generated enough heat and electrical power from digester gas to run their plants and even sell excess electricity. Anaerobic digestion, however, requires complex equipment and fairly skilled operation.

THE STAGES OF TREATMENT AT A WASTEWATER PLANT
Preliminary treatment (A)
Primary treatment (B)
Secondary treatment (C)
Disinfection (D)
▶ Solids handling (E)
▶ Final dispersal or reuse (F)
Refer to the diagram showing these steps on page15.

Aerobic digestion takes place in the presence of oxygen, usually in open containers. It has some similarity to the activated sludge process in that microorganisms are used to consume the biodegradable material in the sludge. Retention times are long enough that almost all biodegradable material is consumed. Some of the advantages of aerobic digestion are that the capital costs of an aerobic digester are less than an anaerobic digester and the required skill level for operation is lower. A disadvantage is that aerobic digesters require significant energy to keep the solids mixed and oxygenated. They do not produce methane that can be used to generate the power needed.

Stabilization by composting also involves the decomposition of organic matter by microorganisms. Composting can take place in either aerobic or anaerobic conditions, but aerobic conditions are almost always maintained as this process is faster. During part of the composting process, heat is generated, which helps to destroy potential pathogens.

Composting processes are classified as *agitated*, in which the materials are mixed to introduce oxygen and keep the process uniform; and *static*, in which the materials are not agitated, but air is forced through the material to keep it oxygenated. There are a number of proprietary composting systems that take place in enclosed reactors or vessels.

It is sometimes beneficial to add other materials, such as straw or leaves, to the solids to enhance the composting process. Wood chips are commonly added as a bulking agent to keep the composting material from becoming too compacted. The chips can be screened out later and reused. Composting results in a material that is hummus-like in consistency that can be used agriculturally.

## Regulation of solids

The processing and final disposal of solids is addressed in the 1993 EPA regulations. These regulations, 40 CFR Part 503, are commonly referred to as the Part 503 rules. They address how biosolids can be applied to land, how they can be disposed, how they must be stabilized to reduce the number of pathogens and make them less attractive to things that spread disease, like mosquitos, and the requirements for incinerators that burn wastewater biosolids.

The Part 503 rules establish two levels of quality for biosolids with regard to pathogens and vector attraction. Class A biosolids are safe for use by the general public and can be used for parks, gardens and golf courses. Class B biosolids do not meet all the established criteria and can be used for application to agricultural land or disposed of in landfills. Reducing the attraction of vectors involves stabilizing the solids so that there is less potential for disease to be spread by birds, insects or rodents. The Part 503 rules also address heavy metal content.



# Lagoons and Decentralized Treatment Options



Midwest Assistance Program

## Lagoons

Much of this guide has focused on the treatment that takes place in mechanical treatment plants. However, as many as one-quarter of all community wastewater treatment systems, mostly in smaller communities, use lagoons and other natural systems, such as marshes and wetlands, to treat their wastewater. Lagoons, or stabilization ponds, in many ways function similarly to mechanical treatment plants. They are designed to provide primary and secondary treatment. Treatment occurs more slowly in lagoons than in mechanical plants. To compensate, the retention time in lagoons is much longer, usually several weeks or more.

The primary advantages of lagoons are that they are less expensive and simpler to construct, operate and maintain. Solids generally accumulate slowly and have to be removed only every ten to 20 years. Their primary disadvantages are that they do not work as well during times of low

temperatures and they take up more space than mechanical plants. The disadvantage of taking up more space, however, is not always a major issue in rural areas, where land is usually more readily available.

Lagoons are classified as aerobic, anaerobic and facultative, based on their oxygen content. Aerobic lagoons have some dissolved oxygen distributed throughout most of the pond, except for the very bottom. Anaerobic lagoons have no dissolved oxygen content. Facultative lagoons have an oxygenated aerobic layer and an anaerobic layer without oxygen.

Lagoons are further classified as aerated and un-aerated. Aerated lagoons use mechanical aerators to maintain some oxygen in the water. The aerators are usually the only major mechanical component of a lagoon system. An aerobic lagoon does not necessarily require mechanical aeration, however. The



oxygen needed by the beneficial bacteria that break down organic matter in the wastewater can often be supplied by the natural transfer of oxygen at the surface of the pond and by oxygen generated by algae in the pond during photosynthesis.



TYPICAL SURFACE  
MECHANICAL AERATOR  
AT AN AERATED LAGOON

Permission granted by Dean Jackson;  
photo courtesy of Keith Larson

Oxygen transfer is affected by the amount of wind, the temperature of the water—more oxygen is dissolved at lower temperatures—and the depth of the lagoon. Un-aerated aerobic lagoons are usually 3 to 8 feet deep, while aerated lagoons are 10 to 15 feet deep.

Most lagoon systems have a number of individual ponds or “cells” that are connected. The cells can be arranged in series, parallel, or a combination of both. As the wastewater passes through a series of ponds, it is expected to improve in quality with each step. Final cells, which are usually lightly loaded, are referred to as “polishing cells.” In some cases, these may be constructed wetlands or marshes.

Anaerobic ponds are typically the first cell in a series of ponds. Solids settle out on the bottom, providing primary treatment. Anaerobic bacteria

convert organic material to simple compounds, such as methane and hydrogen sulfide. These are then oxidized to carbon dioxide, sulfate, and water in a following aerobic cell.

Facultative lagoons have both aerobic and anaerobic zones within the same cell. The anaerobic zones are mostly at the bottom of the pond at the inlet end, where solids enter and settle out to be digested by anaerobic bacteria. The aerobic zone is the upper layer. Facultative lagoons can be mechanically aerated.



AERATED LAGOON CELLS

National Environmental Services Center

Lagoons are constructed through a process of excavation, with the excavated material used to build an earthen dike perimeter. Generally, no earthen material needs to be brought in from offsite. Lagoons are lined with plastics, natural clays, and/or vinyl to prevent seepage.

Lagoon systems are able to provide secondary treatment, effectively reducing the BOD and suspended solids load. However, because the microorganisms that provide the biological treatment are less active in cold weather, treatment is less effective in winter, especially in northern areas. Lagoons located in colder areas are designed to accommodate a certain amount of storage so that wastewater can be retained and discharged only when it meets permit conditions.

## Decentralized wastewater treatment

Approximately 25 percent of homes in the United States are not connected to centralized sewer systems. These homes and businesses collect and treat their wastewater on their own property using systems that are referred to as onsite wastewater treatment systems, septic systems, or decentralized systems.

In some rural and suburban areas, everyone uses decentralized systems. Even in communities with sewers and a centralized treatment facility, there are often areas the sewer does not reach and where homes or businesses are on septic systems. If a community wants to manage all of its wastewater, it is necessary to address both centralized and decentralized systems.

### **Septic system components**

Septic systems are wastewater treatment systems that collect, treat and dispose of wastewater generated by homes or businesses. The wastewater is treated onsite, rather than being collected and transported to a centralized community wastewater treatment plant.

There are several variations of the basic septic system design in use today. While many systems are individually designed or adapted for a specific site, most work using the same basic principles of wastewater treatment, most of which are similar to those discussed previously. A septic system consists of two main parts: a septic tank and a soil-absorption system (SAS), also known as a drainfield, leachfield or disposal field. The entire system is connected by pipes, and a sewer pipe connects the home or business to the septic system.

### **The septic tank**

The main function of the septic tank is to collect household wastewater. The septic tank treats the wastewater naturally by holding it in the tank long enough for solids and liquids to separate. This is equivalent to primary treatment at a wastewater treatment facility.

Treatment begins when the wastewater flows from a building to the septic tank through the sewer pipe. A baffle (an internal flap) or tee (a T-shaped pipe) at the inlet slows the flow of wastewater into the tank and directs it downward toward the middle layer of the tank. The wastewater is then held in the tank for a day or more to allow the solids to separate from the liquids.

Inside the tank, substances lighter than water, such as greases, oils, and sometimes solid materials like toilet paper, float to the top and form a layer of scum. Solids heavier than water settle at the bottom, forming a layer of sludge. This leaves a middle layer of partially clarified wastewater.

A baffle at the outlet of the septic tank allows only the partially treated liquid in the middle layer to flow out for further treatment. The layers of scum and sludge remain in the septic tank, where bacteria found naturally in the wastewater work to break the solids down. This process takes place anaerobically and is equivalent to the anaerobic digestion that

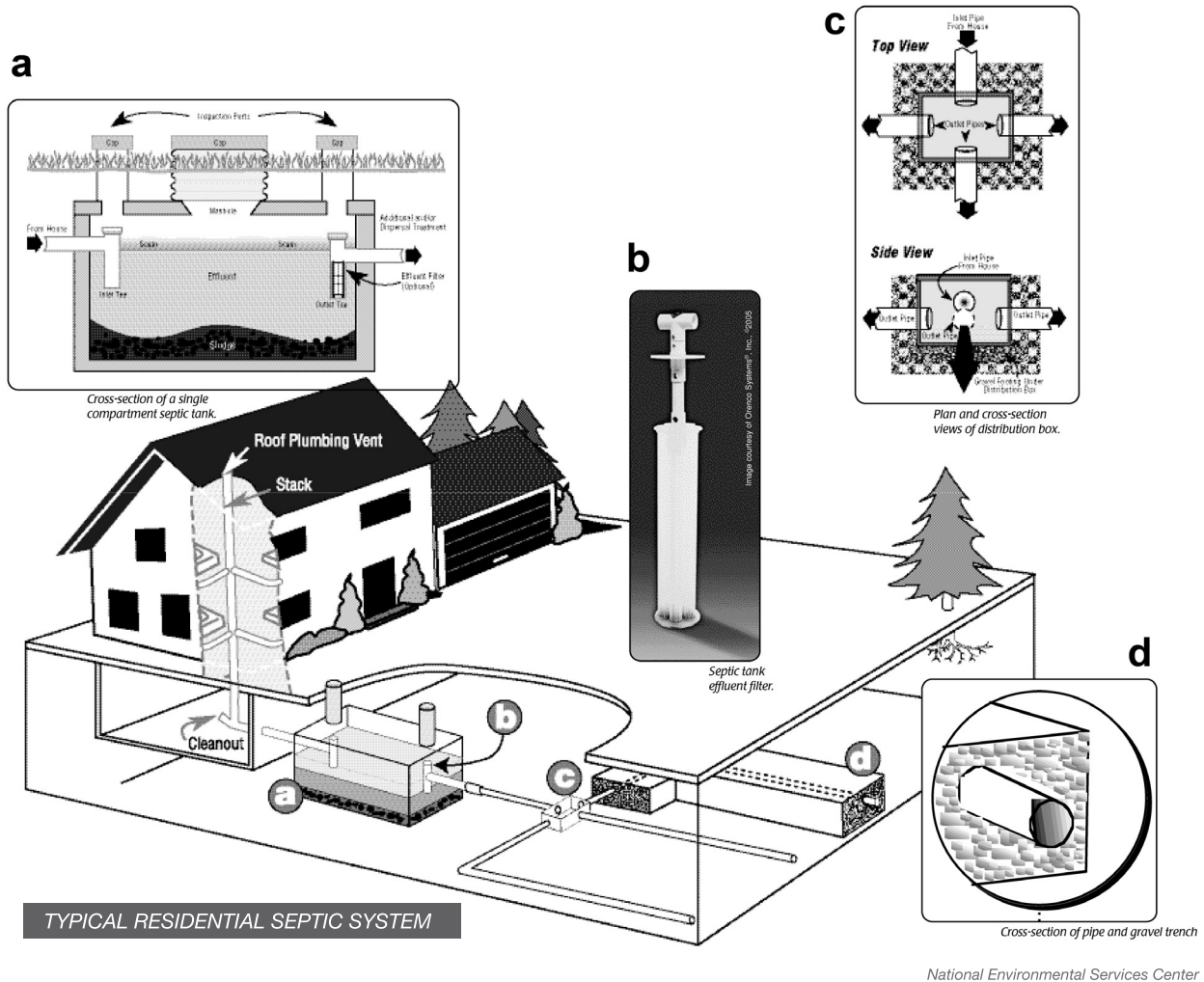

National Environmental Services Center

takes place at treatment plants. Sludge accumulates only gradually because of the digestion. Gases produced from the decaying solids are vented back through the building's sewer line and are usually released through a plumbing vent located on the roof of the house.

The sludge and scum that do not break down are held in the tank until the tank is pumped.

Septic tanks are usually made of precast concrete, fiberglass, or plastic and come in a variety of shapes and sizes. For septic tanks to work properly, they must be watertight and resistant to corrosion. Septic tanks must be large enough to accommodate the needs of the household or building.

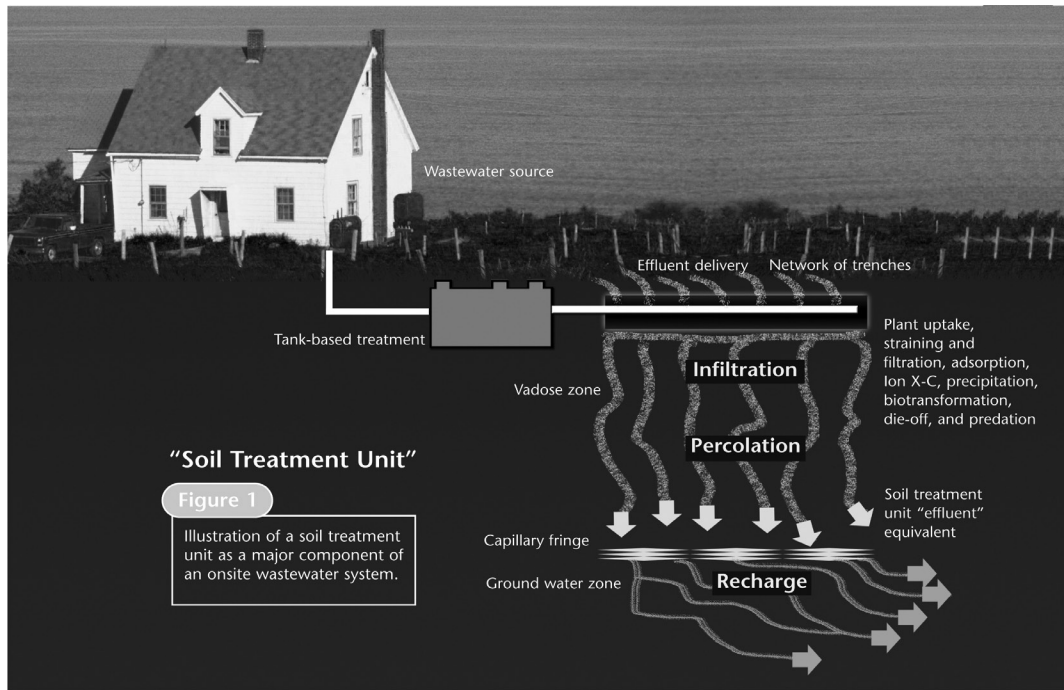

**Figure 1**  
Illustration of a soil treatment unit as a major component of an onsite wastewater system.

Robert L. Siegrist, PhD, PE, BCEE, Colorado School of Mines

### **Soil-absorption system (SAS)**

In a conventional septic system, the wastewater flows by gravity from the septic tank to the SAS or to a distribution device that helps to uniformly distribute the wastewater flow in the drainfield. The soil-absorption field provides the final step in the wastewater treatment process.

The size of an SAS is usually based upon the size of the house or building and the ability of the soil to absorb wastewater, which varies from site to site. A standard field is a series of trenches or a bed lined with gravel or coarse sand that is buried one to three feet underground. Perforated pipes or drain tiles run through the trenches to distribute the wastewater.

The drainfield treats the wastewater by allowing it to slowly trickle from the pipes out into the gravel and down through the soil. The gravel and soil in a drainfield act as biological filters. As the wastewater moves through the soil to the groundwater below, the filtration process and organisms in the soil work together to remove toxics, bacteria, viruses, and other pollutants from the wastewater. A properly functioning drainfield provides treatment that is equivalent to secondary treatment plus some physical filtering.

Soil particles, particularly clay, chemically attract and hold sewage nutrients, metals and disease-carrying organisms. This process can effectively treat the wastewater to an acceptable level that will not contaminate the groundwater. Therefore, it is very important that there is adequate separation between the bottom of the trench/bed and a confining layer, such as groundwater or bedrock.

Certain toxics, such as paints, paint thinners, pesticides, waste oils, and other hazardous chemicals, cannot be treated by the drainfield and should never be disposed of through a septic system.

## Alternative onsite systems

Many properties do not have favorable conditions for installing a conventional septic system with a septic tank and simple gravity-flow drainfield. A site may have poor soil conditions, a high water table, or it may be too small to accommodate a conventional drainfield. In these cases, there are a wide variety of options, referred to as alternative systems. These other systems also provide treatment onsite. They usually involve providing additional treatment so that the water going to the drainfield is of a higher quality or using some alternative form of final dispersal. Sometimes both are necessary.

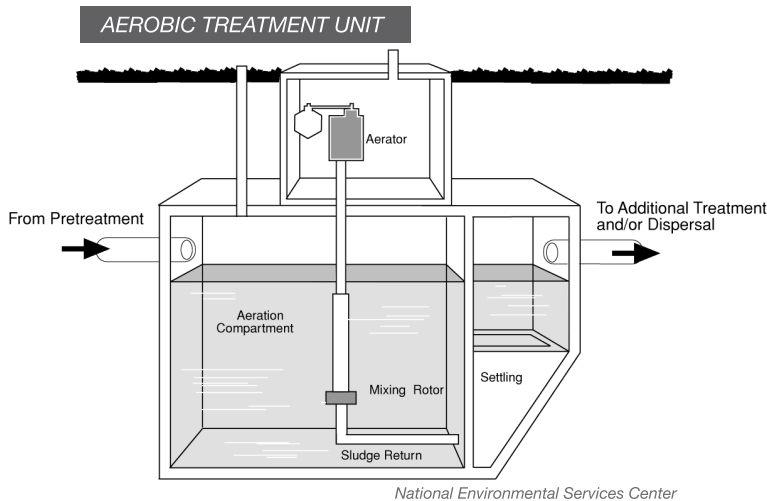

Some examples of alternative or advanced treatment units are aerobic treatment units (ATUs), sand filters, peat filters, and other types of media filters. ATUs are prefabricated modular units that function similarly to small activated sludge treatment plants. They are aerated with a blower or rotor, and aerobic bacteria break down the organic material in the wastewater. Solids are allowed to settle out and may need to be periodically pumped. Some states allow for the surface discharge of disinfected ATU effluent.

Sand filters are constructed of 2 to 3 feet of sand enclosed in an impermeable container.

Septic tank effluent is applied to the filter surface in intermittent doses and is treated as it slowly trickles through the sand. In most sand filters, the wastewater then collects in an underdrain and flows to further treatment and/or dispersal. Some portion of the collected liquid may be re-circulated through the filter for further treatment. Other units may use peat or other types of media, such as plastic. These have some similarities to attached growth units that were discussed previously.

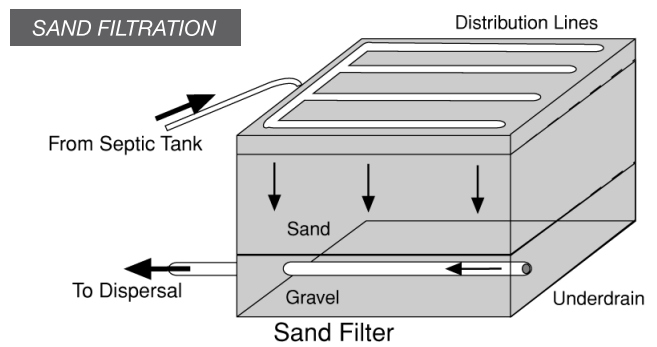

Examples of alternative dispersal options include mound systems and drip dispersal systems. A mound system is a soil-absorption system that is elevated above the natural surface of the soil using a suitable fill material, usually sand. The purpose of the design is to overcome site restrictions, such as slowly permeable soils, shallow permeable soils over creviced or porous bedrock, and permeable soils with high water tables.

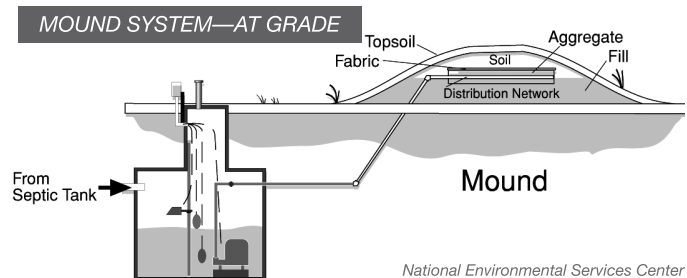

Drip-dispersal systems apply treated wastewater to soil slowly and uniformly from a network of narrow, flexible tubes placed at shallow depths near plant roots. The wastewater is pumped through the drip lines under pressure but drips slowly from a series of evenly spaced openings called emitters. An advantage to these systems is minimal site disturbance due to the flexible tubing that can be placed around trees and shrubs.

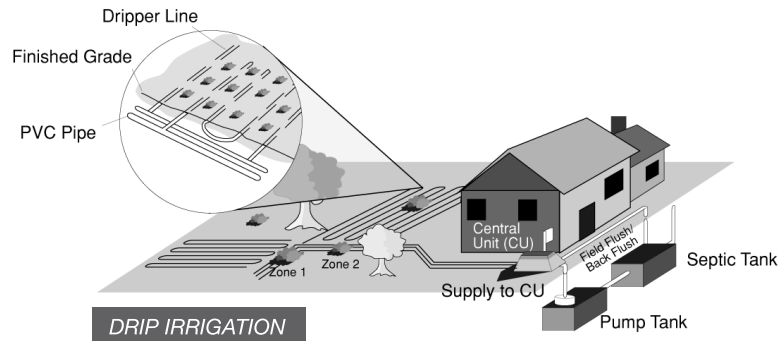

National Environmental Services Center

### Cluster systems

Historically, wastewater management has been thought of either in terms of centralized treatment, with sewers and a central treatment plant, or decentralized treatment, with septic systems. Increasingly, however, there are systems that have some characteristics of both.

Cluster wastewater systems, for example, typically use septic tanks at each individual home or business, but instead of each building having its own soil-absorption system, the effluent is collected from the septic tanks and conveyed to a centralized community drainfield. One advantage is that, because solids are held in the septic tanks, the wastewater is almost all liquid. This allows less expensive, narrow pipe to be used for the sewers. The community drainfield makes it more economically feasible on a per household basis to offer additional treatment before dispersal to the drainfield.

Cluster systems have been used in new developments and to solve problems in areas with existing septic systems that have failed. For example, in lakefront communities with small lots, there may be no space for individual replacement drainfields. A cluster drainfield, or series of cluster drainfields, located away from the lake, may be an economical solution and help protect or restore the lake quality.

# Other Important Things

Providing a safe and efficient wastewater system to residents is one of your community's key responsibilities. But beyond the work performed in the treatment plant or underground are several behind-the-scenes activities to assure that the system runs smoothly and efficiently.

## Operator certification

From the discussion of wastewater treatment processes in this guide, it should be clear that skilled operators and maintenance staff are crucial to the collection and treatment processes. Wastewater treatment involves chemical, biological and physical processes, which in many systems are mechanized. An effective operator needs to be part scientist and part mechanic.

While federal law requires certification and continuing education for operators of all public drinking water systems, there are no federal regulations requiring certification for operators of wastewater plants. However, there are certification requirements for wastewater operators at the level of states, territories and commonwealths, which also provide training for operators.

## Don't flush those meds!

An important part of maintaining an effective wastewater system is keeping outside contaminants from entering the system.

Although wastewater undergoes significant treatment before discharge or reuse, certain contaminants cannot be removed during the process. The most common source of these contaminants is pharmaceuticals and personal care products (PPCPs).

PPCPs include drugs, lotions, soaps, cosmetics and perfumes. Traces of PPCPs are also commonly found in human excrement, making them difficult to eliminate. Leaders of communities or water systems are in a good position to encourage residents or customers (such as through an organized campaign or bill

inserts) to avoid washing, flushing or pouring these items down a drain and into waterways.

Their effects are still being studied, but PPCPs have been found to pose serious health risks when ingested. Researchers studying waterways contaminated with PPCPs have found male fish with female sex characteristics and some fish with both male and female reproductive organs. Scientists have also found that an increased presence of antibiotic soaps and cleaners in waterways has led to the development of antibiotic-resistant bacteria. The potential for harm to human health is not known at this time, but because drinking water is drawn from these same sources, there is a growing concern about how these drugs and other substances may be affecting people, especially with long-term exposure.

As a leader in your community, the most practical way to help reduce the amount of PPCPs in your community's water supply is to encourage the responsible use and disposal of PPCPs. This includes avoiding flushing soap, drugs or lotions down the toilet and limiting the amount of antibacterial soap used in showers and sinks. Residents should return all unused prescription drugs back to the pharmacy for safe disposal. Drugs can also be thrown in the trash, but only after removing them from their original bottle, making them unpalatable by mixing them with wet coffee grounds, glue, or kitty litter, and putting them in a leak-proof container.



AWWA

## Wastewater system management

The overall management of an entire wastewater system is equally important as the technical operation of a treatment plant. Many wastewater systems have failed not because of the inability of the operators but because of poor management. An effective system requires attention to a spectrum of issues that do not directly affect the treatment process, such as the health and safety of the employees, holding on to good staff and developing their skills, record-keeping, knowledge of regulations, and financial management.

Addressing these issues requires the system to generate sufficient revenue to pay for its operation and maintenance, to provide sufficient salaries and benefits that attract and retain operators whose skill levels match what the system requires, to pay for the planned replacement of critical components, and to make payments on any loans.

To ensure that customers are paying a fair share of the costs of operating the system, it is important to know how much wastewater they are generating. In most communities, wastewater rates are based on water usage, because, with the exception of outdoor usage, water that comes into the house as potable water leaves as wastewater that must be treated. Some systems charge higher rates for businesses such as restaurants, laundries and food processors that generate higher-strength wastewater.

With all of this, it is easy to see that skilled management is as important to the success of the system as skilled operators. A wastewater treatment system is a crucial—though typically underappreciated—community asset. As a critical piece of community infrastructure, the wastewater system needs to be maintained so that it continues to fulfill its function into the future.

## A drop of knowledge, but need more?

Now that you have finished reading this guide, you hopefully have a better understanding of wastewater systems. If you have questions, the best person to turn to is most likely your system's operator. As the person who ensures that this system functions properly every day, your operator will be knowledgeable about the processes and issues that have been described in this guide. The additional resources that are listed starting on page 48 are other organizations and institutions that offer a wealth of technical assistance, publications, periodicals, and other types of help for small, rural communities.

### Other RCAP publications to help in the operations and oversight of wastewater systems

If you are a board or council member or staff with responsibilities for overseeing your community's wastewater system, the Rural Community Assistance Partnership (RCAP) has produced many other publications to assist you in these responsibilities. These publications are on the topics of:

- *A Drop of Knowledge: The Non-operator's Guide to Drinking Water Systems* (companion to this guide)
- responsibilities (managerial, financial, legal, etc.) of board members of small water systems
- financial and managerial requirements for communities that are receiving U.S. Department of Agriculture-Rural Utilities Services loans and grants
- registering and reporting requirements for communities that have received American Recovery and Reinvestment Act (ARRA) loans and grants
- planning and resources for sustainable infrastructure for small water systems
- financial management of small water systems
- customer fees (setting rates, hookup fees, fines, etc.)
- developing and managing a water- or sewer-construction project
- water-distribution system maintenance
- asset management and conducting vulnerability assessments and emergency-response planning

All of the above publications can be accessed and downloaded for free (in PDF) on the RCAP website at [www.rcap.org](http://www.rcap.org) (click on "Publications & Resources" on the main menu).

Free resources that can be sent to you regularly: RCAP has a magazine – *Rural Matters* – that is produced every other month. Subscriptions are free. Included in each issue are articles that are useful to small community leaders and system operators. RCAP also produces an electronic newsletter, the eBulletin. Subscribing by email is also free. Each issue provides helpful tips, guides and resources on practical subjects. Find subscription information for both of these resources at [www.rcap.org](http://www.rcap.org) (click on Publications & Resources).





## More on alternative collection systems

### Pressure sewers

A pressure sewer is a narrow pipe into which partially treated wastewater is pumped and then transported under pressure to a final treatment facility or to a conventional gravity sewer main. Narrow pipes can be used with pressure sewers because large and solid materials in the wastewater are separated out or ground up in initial treatment. The pipes are usually made of plastic, which gives them the advantage of being more flexible and more likely to remain watertight than sewers made of clay or concrete. Watertightness is important for maintaining pressurization. The pressure is created by the wastewater being pumped into the pipes at several connections. The pressurized lines eliminate the need for gravity to move the wastewater to its destination. Because of this, the pipe can be laid to follow the natural contour of the land in shallow trenches just below the frost line but deep enough to be kept safe from the traffic above. There are two main types of pressure sewer systems: the septic tank effluent pump (STEP) system and the grinder pump system.

### STEP systems

A STEP system consists of a septic tank to pretreat the wastewater and a submersible, low-horsepower sump pump to push the wastewater through the system. All of the wastewater from each home or business (i.e., the water from sinks, baths, laundry, kitchen and toilets) enters the septic tank from the conventional gravity sewer leaving each building. No special plumbing is normally required.

In the septic tank, the wastewater settles into three layers. Greases and floatable materials rise to the top, solid materials settle to the bottom, and partially clarified liquid remains in the middle. The middle layer, which is called effluent after it leaves the septic tank, will eventually be pumped into the pressure sewers.

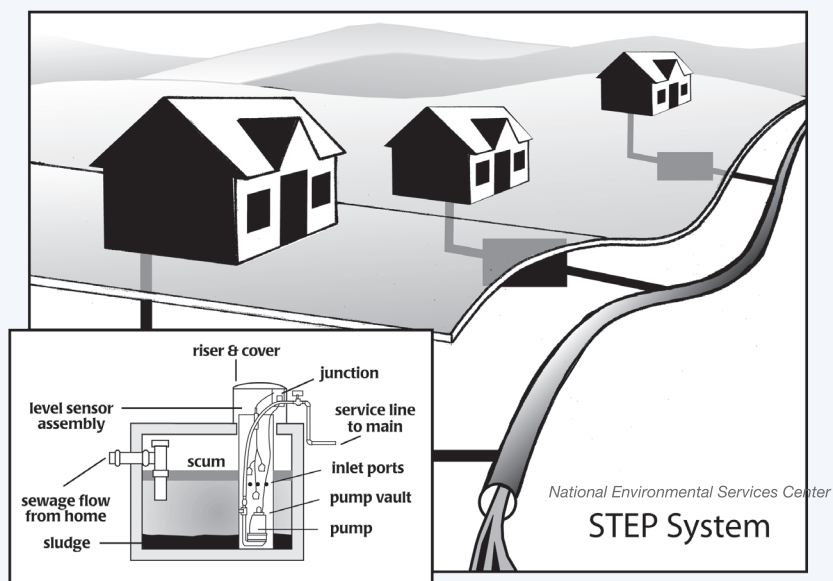

The effluent pump is located in a pumping chamber either inside or next to the tank. The effluent enters the pumping chamber and triggers a sensor when it rises to a certain level. The effluent is then pumped out for a few minutes until the water level is reduced and a lower-level sensor shuts the pump off. There is also a sensor that triggers an alarm if, for some reason, the effluent level gets too high in the pumping chamber.

Because the effluent is relatively free of solids, sewers can be as small as 1.5 inches in diameter for the pipes leading from the service connection and 2 or 3 inches for the mains. This is tiny compared to conventional sewers, which are normally required to have a minimum diameter of 8 inches.

## Grinder pump systems

Grinder pump pressure sewer systems work somewhat differently than STEP systems. With this system, there is no septic tank. Preliminary treatment is done by a grinder pump, which sits in a plastic chamber called a wet well. It usually has a capacity of about 30 gallons.

The grinder pump is similar to a garbage disposal in that solid materials in the wastewater are cut up and ground into tiny pieces. All of the wastewater is then pumped into the pressurized line.

Grinder pumps are usually one or more horsepower and turn on and off according to the levels in the pumping chamber. They are also usually equipped with one or more alarms. Because the wet well does not provide much room for extra wastewater in the case of malfunction, and because there is no septic tank, it is very important that same-day emergency service is available for grinder pump connections.

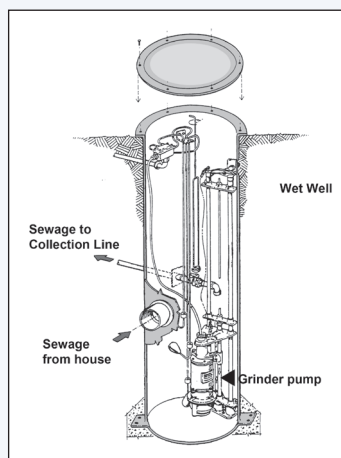

F.E. Myers Co./ National Environmental Services Center

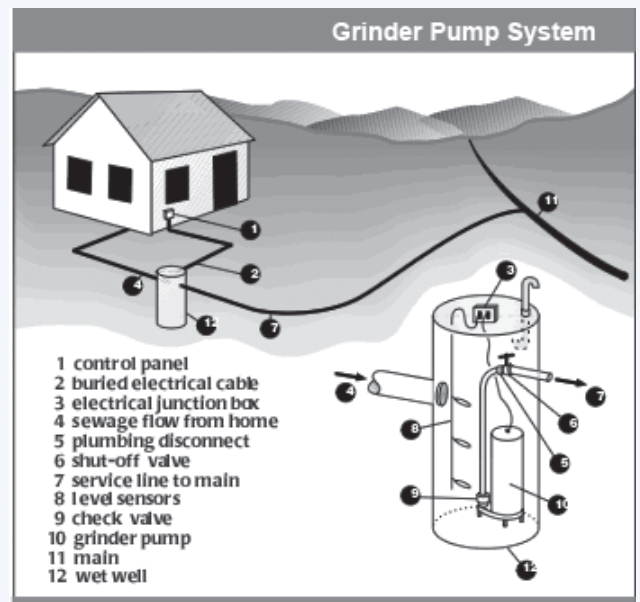

F.E. Myers Co./ National Environmental Services Center

Cleanouts are smaller, less costly, and less likely to leak or require maintenance if properly installed. Systems need to be designed with cleanouts near any pumps, filters, or other parts that may need maintenance or service.

With STEP systems, solids need to be pumped from the septic tank periodically. Depending on the size of the system, communities often have a maintenance management program or a full-time maintenance employee or staff to ensure that the system is being properly operated and maintained at each connection and to handle emergencies. Preventative maintenance is important with this technology because an overloaded septic tank or broken pump at one connection can potentially affect other parts of the system.

## Pressure sewer operation and maintenance

Pressure sewer systems have different operation and maintenance requirements than conventional sewer systems because they use electricity. However, effluent pumps and grinder pumps usually run for only a few minutes per day, so not much energy is used. Power costs are not excessive if the systems are watertight and functioning properly.

Both types of pressure sewer systems use cleanouts instead of manholes as access points for cleaning and monitoring the lines.

## Septic tank effluent gravity sewers

Septic tank effluent gravity (STEG) systems are a third alternative sewer technology for small communities to consider. STEG systems are also known by a variety of other names, including small-diameter gravity sewers, effluent sewers, variable-grade or minimum-grade effluent sewers, small bore sewers, and Australian sewers.

Like conventional sewers, STEG systems use gravity rather than pumps or pressure to collect

and transport wastewater to a facility for final treatment or to empty into a conventional sewer main. As with pressurized STEP sewer systems, STEG systems use septic tanks to provide primary treatment to the household wastewater to allow the bulk of the solid materials to settle out.

These sewers can be narrower than conventional sewers because they collect and transport fewer solids. However, the plastic pipes used for STEG systems need to be somewhat wider (usually a minimum of 3 to 4 inches in diameter) than those used for pressure sewers, for example. This is necessary to accommodate any stray solids that may escape in the effluent of a septic tank that is malfunctioning or overloaded—a particular concern with STEG systems because there are no pumps or pressure in the STEG lines to further break up

or prevent solids from clogging the system.

With only gravity to transport the effluent through the system, the point where the sewer system begins must always be higher than where it ends, and no part of the system can be higher than the starting point. However, STEG systems can be laid at variable grades. Effluent will back up at low spots until more pressure is created to push the wastewater over the “hump” in the pipe, a process called surcharging.

With a septic tank at each connection, the operation and maintenance of STEG connections is similar to STEP and septic systems, including an annual inspection and tank pumping as needed. The STEG system laterals (the pipes going to each service connection) can be accessed and cleaned, if needed, through a series of cleanouts.

## Vacuum sewers

Vacuum sewer systems are another alternative collection technology that is being used more frequently in the United States. They rely on the suction of a vacuum, created by a central pumping station and maintained in the narrow mains, to draw and transport wastewater through the system to final treatment. There are no electrical components at the individual connections to the system.

Most of the vacuum system designs used in the U.S. do not require vacuum toilets or any special plumbing inside the house or building. Wastewater flows from the house by gravity to a holding tank. When the wastewater in the tank reaches a certain level, usually 3 to 10 gallons, a sensor prompts a pneumatic valve to open, and the entire amount of wastewater is sucked into the lines by the vacuum in the sewer main.

At the pumping station, the mains empty into a collection tank. The wastewater is then treated nearby or pumped to another location for treatment. The vacuum pumps are equipped with alarms and an

emergency backup generator in case a power outage or other problem develops.

The initial force of the vacuum pulling the wastewater from the valve pit is usually enough to break up any solids in the wastewater, so narrow plastic pipe can be used for these systems. Usually 3- or 4-inch diameter pipes from the service connection and 4- to 10-inch mains are used for vacuum systems, depending on the flow and design of the system. The vacuum also keeps the lines very clean, so cleanout points are generally unnecessary.

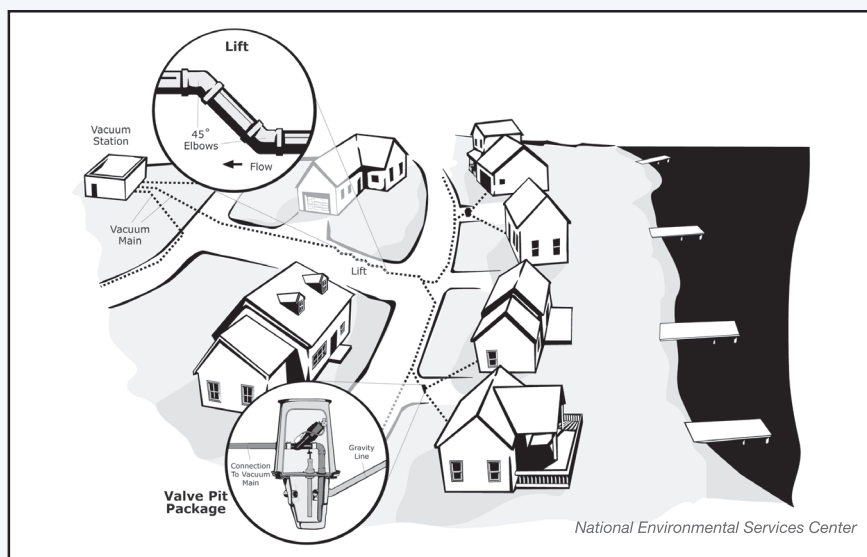

# ADDITIONAL RESOURCES

A number of other organizations and institutions work with small communities on their drinking water and wastewater needs. Here are some of them:

## American Water Works Association (AWWA)

Assists communities in providing safe drinking water and works to educate people on how to operate and manage drinking water systems. A resource for information about water resource development, water and wastewater treatment technology, water storage and distribution, and utility management and operations.

(303) 794-7711  
[www.awwa.org](http://www.awwa.org)

### AWWA Small Systems section

Resources and a helpdesk for small water systems. The site includes both technical and management assistance.

(303) 347-6191  
[smallsystems@awwa.org](mailto:smallsystems@awwa.org)

[www.awwa.org](http://www.awwa.org)

(Click on Professional and Technical Resources → Small Systems)

## Association of Boards of Certification (ABC)

Includes almost 100 certifying authorities and represents more than 40 states. These boards certify more than 150,000 water and wastewater operators, laboratory analysts, plant maintenance technologists, bio solids land appliers, and backflow-prevention assembly testers.

(515) 232-3623  
[www.abccert.org](http://www.abccert.org)

## National Environmental Health Association (NEHA)

A membership organization dedicated to advancing environmental health and protection professionals works to establish a standard of excellence for the professional and works to establish a standard of excellence for the profession

(303) 756-9090  
[www.neha.org](http://www.neha.org)

## National Environmental Services Center (NESC)

Assists small and rural communities with their drinking water, wastewater, environmental training, infrastructure resilience, and utility-management needs and helps them find solutions to problems they face. Provides toll-free technical assistance, training materials, publications, and free and low-cost products. Authored this guide and its companion on drinking water systems (*A Drop of Knowledge: The Non-operator's Guide to Drinking Water Systems*).

(800) 624-8301  
[www.nesc.wvu.edu](http://www.nesc.wvu.edu)

## National Rural Water Association (NRWA)

Helps states solve compliance problems. Combines both formal and classroom training with follow-up, on-site technical assistance to both member and non-member systems.

(580) 252-0629  
[www.nrwa.org](http://www.nrwa.org)

## National Water Resources Association (NWRA)

Advocates federal policies, legislation and regulations promoting protection, management, development, and beneficial use of water resources that represent the interests of its members.

(703) 524-1544  
[www.nwra.org](http://www.nwra.org)

## Rural Community Assistance Partnership (RCAP)

National office  
(800) 321-7227  
[info@rcap.org](mailto:info@rcap.org)  
[www.rcap.org](http://www.rcap.org)

### Regional partners

See the inside back cover of this guide for contact information for RCAP's six regional partners. These are the organizations that coordinate RCAP's work in your state and its communities.

## [www.SmallWaterSupply.org](http://www.SmallWaterSupply.org)

Free online resources and support for small community water and wastewater operators

## Water Environment Federation (WEF)

Develops and promotes practices and policies that help members serve the public interest by providing efficient and environmentally protective water quality and wastewater management services.

(800) 666-0206  
[www.wef.org](http://www.wef.org)

---

## Water-Wastewater Agency Response Network (WARN)

A network of utilities helping other utilities to respond to and recover from emergencies. While the WARN initiative is coordinated by the American Water Works Association (AWWA), WARNs are organized on a state-by-state basis and are managed by the utilities themselves. A WARN assists water/wastewater utilities in providing mutual aid whenever a significant service interruption may require support beyond a local utility's immediately available resources. The goal is to assist in the rapid recovery of service for the protection of the public health, the environment and your local community.

<http://apps.awwa.org/EbusMain/Default.aspx?TabID=283>

---

## Federal government resources

The primary agencies involved in small community water and wastewater issues are:

### U.S. Department of Agriculture (USDA)

#### Rural Utilities Service (RUS)

(202) 720-9583  
[www.usda.gov/rus](http://www.usda.gov/rus)

#### Rural Utilities Service (RUS), Water and Environmental Programs

[www.usda.gov/rus/water/index.htm](http://www.usda.gov/rus/water/index.htm)

---

### U.S. Environmental Protection Agency (EPA)

#### Office of Water

(202) 272-0167  
[www.epa.gov/aboutepa/ow.html](http://www.epa.gov/aboutepa/ow.html)

#### Small Public Water Systems and Capacity Development

<http://water.epa.gov/type/drink/pws/smallsystems/index.cfm>

#### Ground Water & Drinking Water

<http://water.epa.gov/drink/index.cfm>

#### Safe Drinking Water Hotline

(800) 426-4791  
<http://water.epa.gov/drink/hotline/index.cfm>

---

### U.S. Department of Health and Human Services

(877) 696-6775  
[www.hhs.gov](http://www.hhs.gov)

---

### U.S. Geological Survey

(703) 648-5953  
[www.usgs.gov](http://www.usgs.gov)

---

## Find your...

### State primacy agency

[www.asdwa.org/index.cfm?fuseaction=Page.viewPage&pageId=487](http://www.asdwa.org/index.cfm?fuseaction=Page.viewPage&pageId=487)

---

### State and local health departments

[www.healthguideusa.org/local\\_health\\_departments.htm](http://www.healthguideusa.org/local_health_departments.htm)

---

### State's USDA-Rural Development office

[www.rurdev.usda.gov/recd\\_map.html](http://www.rurdev.usda.gov/recd_map.html)

---

### EPA Region

<http://water.epa.gov/type/location/regions/>

---



# GLOSSARY

## A

**Activated sludge**—sludge particles produced in wastewater by the growth of organisms in aeration tanks. The term *activated* comes from the fact that the particles teem with bacteria, fungi and protozoa. Activated sludge is different from primary sludge in that the sludge particles contain many organisms that feed on incoming wastewater.

**Activated sludge process**—a biological wastewater treatment process that speeds up waste decomposition. Activated sludge is added to wastewater, and the mixture is aerated and agitated. After some time, the activated sludge settles out through sedimentation and is disposed of or returned to the aeration tank to be reused.

**Aerobic**—a condition in which free oxygen is present

**Aerobic digestion**—a biological sludge-stabilization process that takes place in an oxygenated environment

**Aerobic lagoon**—a wastewater treatment pond that has some dissolved oxygen present

**Aerobic treatment unit (ATU)**—prefabricated units that provide wastewater treatment by injecting air into a tank, allowing aerobic bacteria to break down organic matter. Usually used for onsite or decentralized wastewater treatment.

**Alkalinity**—the capacity of water to neutralize acid. Alkalinity is not the same as pH because water does not have to be strongly basic (high pH) to have a high alkalinity.

**Algae**—aquatic plants that grow in sunlit water and release oxygen into the water

**Alternative system**—a wastewater treatment or collection system that is used instead of a conventional system

**Anaerobic**—a condition lacking free oxygen

**Anaerobic digestion**—a sludge-stabilization process that takes place in an environment without oxygen

**Anaerobic lagoons**—wastewater treatment ponds that have no dissolved oxygen content

**Anoxic**—a condition without free oxygen but nitrate is present.

**Attached growth process**—a wastewater treatment process in which microorganisms providing treatment are attached to an inert surface, such as rock or plastic. It is also referred to as **fixed-film process**.

## B

**Bacteria**—single-celled organisms that help consume and decompose the organic components of wastewater

**Belt-filter press**—a sludge de-watering device that uses two fabric belts to squeeze water from the sludge

**Biochemical oxygen demand (BOD)**—a measure of organic matter in water based on the amount of oxygen consumed in biological processes that break down this organic matter

**Biomass**—a microbial growth

**Biosolids**—treated sewage sludge solids that have been stabilized to destroy pathogens and that meet rigorous standards that allow for safe reuse as a an additive to soil

**Black water**—domestic wastewater that carries human waste. Often synonymous with toilet water; however, some states include food waste (i.e., kitchen sink water) in this category.

## C

**Centralized wastewater treatment**—treatment through which wastewater is transported by a network of sewers to a central treatment facility

**Chlorination**—the process of adding chlorine gas or chlorine compounds to wastewater for disinfection.

**Clarifier**—removes solids from wastewater by gravity settling or by coagulation. Also referred to as a **settling tank** or **sedimentation tank**.

**Class A biosolids**—biosolids that meet the criteria of the Part 503 rules, allowing them to be used in parks, gardens and golf courses

**Class B biosolids**—biosolids that do not meet all the criteria for Class A biosolids. They may be applied to agricultural land or disposed of in landfills

**Clean Water Act**—aims to restore and maintain the “chemical, physical, and biological integrity of the nation’s water.” It is the main federal law that serves to regulate facilities, including wastewater treatment plants that discharge wastewater into surface waters.

**Cluster system**—a wastewater treatment system that uses septic tanks at individual houses to remove solids and small-diameter sewers to transport the liquid effluent to a central area for additional treatment and/or dispersal. This is often achieved through a community soil-absorption system.

**Coagulation**—the clumping of solids to make them settle out of wastewater faster. Coagulation of solids is improved by the use of chemicals, such as lime, alum, iron salts or polymers.

**Coliform bacteria**—rod-shaped bacteria that live in the intestinal tracts of human and other warm-blooded animals. Coliform bacteria are often used as indicators of fecal contamination and the potential presence of pathogenic microorganisms.

**Colloidal**—particles in suspension in wastewater that are too small to readily settle out during primary treatment

**Combined sewers**—system of pipes that carries both sanitary sewage and storm water runoff

**Comminutor**—a device to catch and shred heavy solid matter at the headworks of a wastewater treatment plant

**Composting**—the natural biological decomposition of organic material in the presence of air to form a stabilized material that is humus-like in consistency

**Conditioning**—the addition of chemicals to sludge to aid in the dewatering process. Conditioning chemicals include alum, lime, ferric chloride, and synthetic organic polymers.

**Conventional septic system**—a septic system with a standard septic tank and soil-absorption system and in which the wastewater flow is moved by gravity

## D

**Decentralized wastewater treatment**—process in which wastewater treatment takes place close to where wastewater was generated. Often refers to some variation of a septic system that serves an individual home, business or small group of homes.

**Denitrification**—the reduction of nitrate to nitrogen gas that is carried out in wastewater treatment tanks by bacteria under anoxic conditions. The bacteria use the nitrate for energy, and in the process release nitrogen gas. The nitrogen gas, a major component of air, is released to the atmosphere.

**Disinfection**—the killing of microorganisms, including some disease-causing ones

**Disinfection by-products (DBPs)**—compounds that are formed during the disinfection process of water or wastewater by the chemical reaction of the disinfectants and organic matter. Many DBPs are considered to be harmful to aquatic life and human health.

**Dissolved oxygen**—the amount of free oxygen in solution in water or wastewater effluent. Adequate concentrations of dissolved oxygen are necessary for fish and other aquatic organisms to live and to prevent offensive odors.

**Drainfield**—the part of a septic system where clarified liquid effluent is dispersed into soil for final treatment and disposal. Also referred to as a **soil-absorption system** or **leachfield**.

**Drip dispersal**—a form of final dispersal of treated wastewater in which the effluent is applied to soil slowly and uniformly through a network of narrow, flexible tubes placed in the soil at shallow depths. Also referred to as **drip irrigation**.

## E

**Effluent**—the liquid that comes out of a treatment plant after completion of the treatment process. Also refers to the liquid from a particular unit, such as primary effluent (from the primary treatment process) or septic tank effluent, even though the effluent requires further treatment.

**Eutrophication**—the slow aging process by which a lake evolves into a bog or marsh, ultimately disappearing. During eutrophication, the lake becomes enriched with nutrients, especially nitrogen and phosphorus, which support the excess production of algae and other aquatic plant life.

**Exothermic**—a chemical reaction that releases energy in the form of heat

**Extended aeration**—a variation of the activated sludge treatment process with a long detention time that results in heavy competition for food by the microorganisms and little production of sludge

## F

**Facultative lagoons**—a wastewater treatment pond that contains some areas where dissolved oxygen is present and others where oxygen is absent

**Fixed film system**—a wastewater treatment process in which the microorganisms providing the treatment are attached to an inert surface or medium, such as rock or plastic. It is also referred to as **attached growth process**.

**Floc**—clumps of solids formed in sewage through biological or chemical action

**Flocculation**—a chemical process by which clumps of solids in sewage are made to increase in size

**F:M**—food to microbe ratio

## G

**Gray water**—domestic wastewater composed of wash water from sinks, showers and washing machines. It does not include toilet wastewater.

**Grit chamber**—a small detention basin designed to permit the settling of coarse, heavy inorganic solids, such as sand, while allowing the lighter, organic solids to pass through the chamber

## H

**Headworks**—the part of the wastewater treatment plant where the influent or raw sewage enters the plant

**Helminths**—parasitic roundworms or flatworms

## I

**Indicator organisms**—microorganisms whose presence in a water sample indicate the presence of fecal contamination and possibly pathogenic microorganisms

**Infiltration**—the penetration of water through the ground into underground soil or the passing of water from the soil into a pipe, such as a sewer

**Influent**—water, wastewater or other liquid flowing into a reservoir, basin or treatment plant, or a unit of the treatment plant

**Inorganic**—compounds that do not contain carbon from a plant or animal source or synthetic organic carbon

**Interceptors**—large sewer lines that collect the flows from smaller main and trunk sewers and carry them to the treatment plant



## J

**Jar test**—a laboratory procedure that simulates on a small scale what is happening in the plant. It may be used to provide information about sludge settleability or to optimize chemical dosing or settling times.

## L

**Lagoon**—a pond (usually constructed) in which algae and aerobic and anaerobic bacteria purify wastewater

**Lateral sewers**—small underground pipes that transport sewage from homes and businesses to the larger sewer lines leading to a wastewater treatment plant

**Leachfield**—the part of a septic system where clarified liquid effluent is dispersed into soil for final treatment and disposal. Also referred to as a **drainfield** or **soil-absorption system**.

**Loading**—the quantity of material added to a process at one time

## M

**Membrane filtration**—a water and wastewater treatment process, such as reverse osmosis, microfiltration, ultrafiltration or nano-filtration, which uses fine-pore membranes and pressure to remove small particles from the water

**Mixed liquor**—activated sludge mixed with wastewater in an activated sludge treatment process

**Mixed liquor suspended solids (MLSS)**—the suspended solids in the mixture of activated sludge and wastewater that undergoes aeration in an activated sludge treatment process

**Mound system**—an effluent disposal system involving a mound of sand built on the original ground surface to which effluent is distributed

## N

**National Pollutant Discharge Elimination System (NPDES)**—a program established by the Clean Water Act that requires all wastewater discharges into U.S. waters to obtain a permit issued by the U.S. Environmental Protection Agency (EPA) or a state agency authorized by the EPA

**Nitrification**—the biochemical oxidation of ammonium to nitrate

**Nutrients**—elements or compounds essential as raw materials for plant and animal growth and development

## O

**Organic matter**—compounds that contain carbon. The term often refers to compounds in plants, animals and wastes; however, there are also manmade organic compounds

**Overland flow**—land treatment of wastewater involving the controlled application of wastewater onto grass-covered gentle slopes with impermeable surface soils. As water flows over the grass-covered soil surface, contaminants are removed, and the water is collected at the bottom of the slope for reuse.

**Oxidation ditch**—a variation of the activated sludge treatment process that takes place in an oval channel with aeration provided by various types of mechanical devices that move around the channel

**Ozonation**—a disinfection process in which ozone is generated and added to wastewater effluent to kill pathogenic organisms

## P

**Part 503 rules**—federal rules established in 1993 by the U.S. Environmental Protection Agency that address how wastewater biosolids can be applied to land, how they can be disposed, how they must be stabilized, and what the requirements are for incinerators that burn biosolids

**Pathogens**—disease-causing microorganisms, including certain bacteria, viruses, helminths and protozoans

**Peat filter**—a type of alternative or advanced onsite wastewater treatment system. Peat filters involve the application of septic tank effluent to peat fibers housed in impermeable containers. As the effluent trickles through the peat, additional treatment is provided by microorganisms attached to the peat surface. The containers include an underdrain that collects the treated liquid, which is then dispersed, usually to a soil-absorption system.

**Permeability**—a measure of the ease with which water penetrates or passes through soil

**Pressure sewer**—a system of pipes in which the wastewater is transported under pressure supplied by pumps

**Primary clarifier**—a tank used in the primary treatment process that provides a non-turbulent environment allowing heavier solids to settle out and floatable materials to come to the surface where they may be separated. Also referred to as a **primary sedimentation tank**.

**Primary sludge**—sludge produced in the primary wastewater treatment process

**Primary treatment**—the initial stage of wastewater treatment that removes floating material and material that easily settles out

**Protozoans**—a group of one-celled microorganisms, generally larger than bacteria, some of which feed on bacteria and some of which are pathogens

## R

**Rapid infiltration**—a method of final treatment and dispersal of wastewater effluent by spreading the effluent over highly permeable soils, such as sand and loam

**Receiving waters**—water bodies, such as rivers, lakes and oceans, that receive discharges of treated or untreated wastewater

**Rotating biological contactor (RBC)**—an attached growth wastewater treatment process involving large, closely spaced plastic discs mounted on a revolving horizontal shaft. The discs alternately move through the wastewater and the air, developing a biological growth on the surface of the discs that removes organic material in the wastewater.

## S

**Sand filter**—a type of alternative or advanced onsite wastewater treatment unit. It involves the intermittent application of septic tank effluent to sand that is enclosed in a container, usually 2 or 3 feet in depth. The effluent receives further treatment as it trickles through the sand and is collected in an underdrain for further treatment or dispersal. Sand filters are classified as single-pass, in which the effluent is applied to the filter once, or recirculating, in which a portion of the liquid collected in the underdrain is recycled back to be applied to the filter again.



**Sanitary sewers**—the collection system for transporting domestic and industrial wastewater to municipal wastewater treatment facilities. Storm water is not directed into this system but is handled by a separate system.

**Secondary clarifier**—a clarifier following a secondary treatment process, designed for removal of suspended matter by gravity

**Secondary sludge**—sludge produced during the secondary treatment process

**Secondary treatment**—the stage in wastewater treatment in which bacteria consume the organic matter in wastewater. Federal regulations define secondary treatment as meeting minimum removal standards for BOD, TSS and pH in the discharged effluents from municipal wastewater treatment facilities.

**Septage**—the residual solids in septic tanks or other onsite wastewater treatment systems that must be removed periodically for disposal

**Septic system**—a wastewater system designed primarily for individual residences. It uses a septic tank to provide sedimentation, sludge digestion, and sludge storage, and a soil-absorption system or drainfield to provide final dispersal and treatment of the liquid effluent.

**Septic tank**—one of the primary components of a septic system in which heavier solids are allowed to settle out and lighter materials form a floating layer. An outlet is configured such that only relatively clarified liquid flows to the drainfield or soil-absorption system for final treatment and dispersal.

**Septic tank effluent pump (STEP) sewer**—a type of pressure sewer that uses a septic tank to eliminate most solids and a pump to push the liquid effluent through the sewers. Because there are very little solids in the sewage, very narrow pipes can be used.

**Sequencing batch reactor (SBR)**—a variation of the activated sludge process in which all treatment processes occur in one tank that is filled with wastewater and drawn down to discharge after treatment is complete

**Settleable solids**—solids that are heavier than water and settle out of water by gravity

**Sludge**—solids that settle out

during a treatment process

**Sludge drying bed**—a constructed bed of sand used to dewater sludge. An underdrain is used to collect the separated water.

**Soil-absorption system (SAS)**—the part of a septic system in which the clarified liquid effluent is dispersed into soil for final treatment and disposal. The SAS, also referred to as a **drainfield** or **leachfield**, is typically made up of a series of trenches or a bed lined with gravel or coarse sand. The effluent is dispersed through a network of perforated pipes or drain tiles.

**Solids retention time (SRT)**—the average amount of time that sludge remains in an activated sludge treatment process. It is a critical part of the treatment process that an operator watches because it determines how well the process works.

**Stabilization**—any process used to produce a final biosolids product that has little or no potential to further decompose and create undesirable odors and that is free of pathogens

**Storm sewers**—a separate system of pipes that carry rain and snow melt from buildings, streets and yards to surface waters

**Suspended growth process**—a wastewater treatment process in which the microorganisms providing the treatment are maintained in suspension in the wastewater

**Suspended solids**—the small particles suspended in water or wastewater

## T

**Tertiary treatment**—any physical, chemical or biological wastewater treatment process that is used to improve the quality of secondary effluent

**Thickening**—any process to decrease the volume of sludge by removal of some of the liquid portion

**Total dissolved solids (TDS)**—a measure of the dissolved matter in a sample of water or wastewater. It is obtained by passing the sample through a filter, evaporating the water and weighing the dried residue of the material that passed through the filter. TDS includes some colloidal matter that is small enough to pass through the filter.

**Total suspended solids (TSS)**—a measure of the suspended matter in

a sample of water or wastewater. It is measured by passing the sample through a filter, evaporating the water, and weighing the dried residue that was retained on the surface of the filter.

**Trickling filter**—an attached growth process that involves a tank, usually filled with a bed of rocks, stones, or synthetic media, to support bacterial growth used to treat wastewater

## U

**Ultraviolet (UV) disinfection**—a disinfection process in which wastewater is exposed to UV light to kill or deactivate potential microbial pathogens

## V

**Vacuum sewer**—an alternative sewer system that uses a vacuum (created by a central vacuum station and maintained in the lines) to draw and transport wastewater through the system to a final treatment unit

**Vector**—an insect or any living carrier (birds, rats) that transmits an infectious agent

**Voluminous**—large in volume or bulk

## W

**Wasting**—removal of excess microorganisms from a secondary treatment system





# Need help with your community's water or wastewater system?

The Rural Community Assistance Partnership (RCAP) is a national network of nonprofit organizations working to ensure that rural and small communities throughout the United States have access to safe drinking water and sanitary wastewater disposal. The six regional RCAPs provide a variety of programs to accomplish this goal, such as direct training and technical assistance, leveraging millions of dollars to assist communities develop and improve their water and wastewater systems.

If you are seeking assistance in your community, contact the office for the RCAP region that your state is in, according to the map below. Work in individual communities is coordinated by these regional offices.



## Rural Community Assistance Partnership

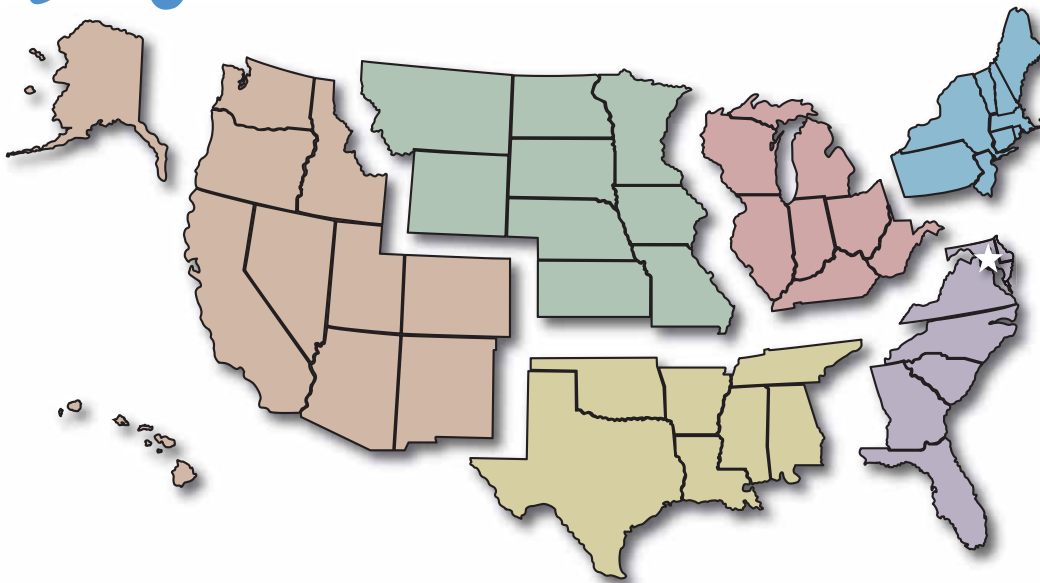

### Western RCAP

#### **Rural Community Assistance Corporation**

3120 Freeboard Drive, Suite 201  
West Sacramento, CA 95691  
(916) 447-2854  
[www.rcac.org](http://www.rcac.org)

### Midwest RCAP

#### **Midwest Assistance Program**

P.O. Box 81  
212 Lady Slipper Avenue NE  
New Prague, MN 56071  
(952) 758-4334  
[www.map-inc.org](http://www.map-inc.org)

### Southern RCAP

#### **Community Resource Group**

3 East Colt Square Drive  
Fayetteville, AR 72703  
(479) 443-2700  
[www.crg.org](http://www.crg.org)

### Northeast RCAP

#### **RCAP Solutions**

P.O. Box 159  
205 School Street  
Gardner, MA 01440  
(800) 488-1969  
[www.rcapsolutions.org](http://www.rcapsolutions.org)

Puerto Rico  
(Northeast RCAP)  
and U.S. Virgin  
Islands (RCAC)

### Great Lakes RCAP

#### **WSOS Community Action Commission**

P.O. Box 590  
219 S. Front St., 2nd Floor  
Fremont, OH 43420  
(800) 775-9767  
[www.glrca.org](http://www.glrca.org)

### Southeast RCAP

#### **Southeast Rural Community Assistance Project**

P.O. Box 2868  
347 Campbell Ave. SW  
Roanoke, VA 24016  
(866) 928-3731  
[www.southeastrcap.org](http://www.southeastrcap.org)

### ★ RCAP National Office ★

1701 K Street NW, Suite 700 • Washington, DC 20006  
202/408-1273 • 800/321-7227  
[www.rcap.org](http://www.rcap.org)



Rural Community Assistance Partnership, Inc.

1701 K St. NW, Suite 700

Washington, DC 20006

202/408-1273

800/321-7227 (toll-free)

info@rcap.org

[www.rcap.org](http://www.rcap.org)

Visit our website for other publications, electronic and print periodicals, and ways your community can get assistance with its water and wastewater system.